

supex



2025

EXPERIENCE YOUR EVERYWHERE

WITH GEAR YOU CAN TRUST

WELCOME

We're here to make exploring the outdoors easier and more fun for everyone. As we step into 2025 we're thrilled to present our updated collection of gear. All designed to make your adventure more enjoyable, whether you're setting out on a weekend getaway, exploring the backcountry, or simply enjoying the beauty of the outdoors.

Our family's love for the great outdoors has driven us, born from our genuine passion to equip fellow adventurers with top-notch gear. Three generations later, we continue to inspire and support adventurers and explorers with gear and advice they can trust.

Here's to another great year.



TOUR & RV

04 | RV ESSENTIALS & ACCESSORIES

18 | CARAVAN AWNING & ACCESSORIES

28 | ENSUITE

32 | ELECTRICAL & 12V

44 | RV & TRAILER HARDWARE

CAMP & OUTDOORS

52 | BEDDING

54 | FURNITURE

62 | COOKWARE

70 | BEACH & SHELTER

74 | CAMPSITE ACCESSORIES

80 | MAINTENANCE & REPAIR

84 | ROPES & PEGS

92 | POLES & SPREADER BARS

98 | INDEX

RV ESSENTIALS & ACCESSORIES



SINGLE AXLE WHEEL LEVELLING RAMP

CODE: SRWLS

- To suit single axle vans
- Weight Rating: 5 tonnes
- Includes carry bag, two ramps, two chocks

Dimensions:
560mm (l) x 200mm (w) x 130mm (h)



DUAL AXLE WHEEL LEVELLING RAMP

CODE: SRWLD

- To suit dual axle vans
- Weight Rating: 5 tonnes
- Includes carry bag, two ramps, two chocks

Dimensions:
430mm (l) x 190mm (w) x 90mm (h)



WHEEL CHOCK

CODE: SRWWCH

- Wheel chock with rubber grip along base
- Australian made

Dimensions:
210mm (l) x 200mm (w) x 110mm (h)



DUAL AXLE WHEEL CHOCK

CODE: SRWWCHD

- Interlocking poly wheel chock for dual axle caravans
- Separable for single axle caravans
- Rubber grip along base

Dimensions (when interlocked):
450mm (l) x 209mm (w) x 119mm (h)



RV LEVEL BLOCK SET

CODE: SRWLCHB

- Eight piece set to customise ramp height to suit ground and vehicle
- Includes carry bag
- Includes six HDPE levels and two rubber tops
- Weight Rating: 3 tonnes

Dimensions (for one levelling block):
215mm (l) x 215mm (w) x 40mm (h)





FULLY CUSTOMISED | ADJUST PACK ITEMS TO YOUR REQUIREMENTS | INCLUDE YOUR BRANDING

STANDARD STARTER PACK

CODE: SCSP

Contains:

- 1 x 10m drinking water hose with fittings
- 1 x 10m sullage hose, 25mm dia.
- 1 x 10m, 15amp caravan lead
- 1 x Drinking Water Hose storage bag
- 1 x Sullage Hose storage bag
- 1 x Electrical Lead bag

Comes in a reusable bag



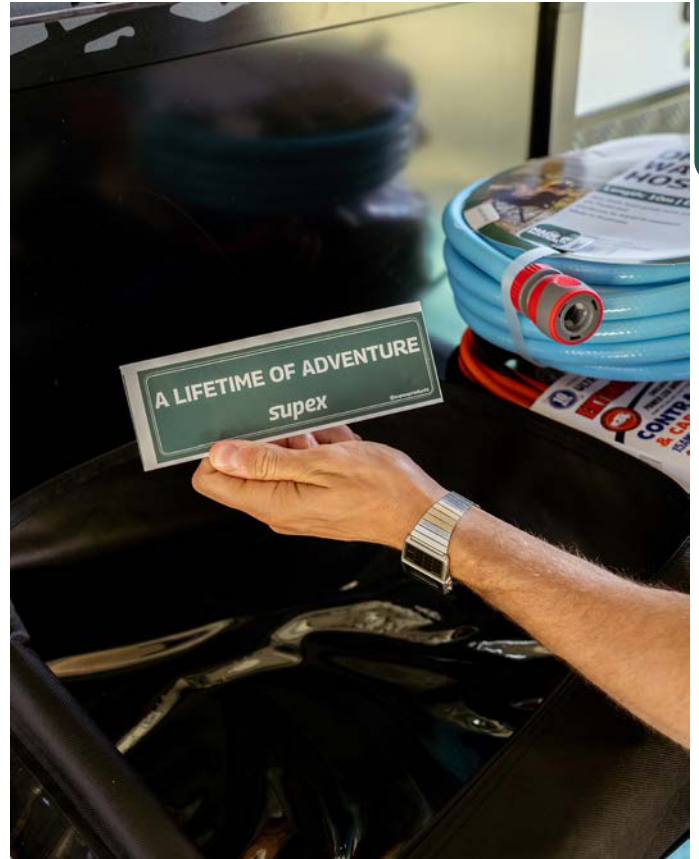

FULLY CUSTOMISED | ADJUST PACK ITEMS TO YOUR REQUIREMENTS | INCLUDE YOUR BRANDING

DELUXE STARTER PACK

CODE: DCSP

Contains:

- 1 x 10m drinking water hose with fittings
- 1 x 10m sullage hose, 25mm dia.
- 1 x 10m, 15amp caravan lead
- 1 x Drinking Water Hose storage bag
- 1 x Sullage Hose storage bag
- 1 x Electrical Lead bag
- 1 x T-level
- 1 x levelling ramp set

Comes in a reusable bag



WITH GEAR YOU CAN TRUST



DRINKING WATER HOSE

CODE: DRW10 | 10m coil hose, fittings not inc.
 CODE: DRW20 | 20m coil hose, fittings not inc.
 CODE: DRW10HF | 10m coil hose, fittings inc. tap ready
 CODE: DRW20HF | 20m coil hose, fittings inc., tap ready

- Food grade drinking water hose, 12mm



DRINKING WATER HOSE, BLACK

CODE: DRW1230 | 12mm dia. x 30m coil
 CODE: DRW2530 | 25mm dia. x 30m coil

- Food grade drinking water hose, black
 - Liquid transfer hose, non-pressure



SULLAGE HOSE

CODE: ISH2510 | 25MM DIA. X 10M COIL
 CODE: ISH285 | 28MM DIA. X 5M COIL
 CODE: ISH2810 | 28MM DIA. X 10M COIL
 CODE: ISH325 | 32MM DIA. X 5M COIL
 CODE: ISH3210 | 32MM DIA. X 10M COIL
 CODE: ISH385 | 38MM DIA. X 5M COIL
 CODE: ISH3810 | 38MM DIA. X 10M COIL

- For effective grey water drainage
 - Smooth bore style reduces particle blockage
 - Strong, flexible material prevents holes and leaks



EXTRA FLEXIBLE SULLAGE HOSE

CODE: SUL5F | 25mm dia. x 5m coil

- Interlockable extra flexible sullage hose
 - With 40mm adaptor and interlockable threaded end to join two hoses together for 10m length
 - Strong material prevents holes and leaks

HOSE FITTINGS

1. CODE: HC4035 | Hose reparer, 12mm
2. CODE: HC4011 | Sprinkler adaptor, 19mm BSP tail
3. CODE: HC4111 | Hose connector, 12mm
4. CODE: HC4018 | Tap nut adaptor, 19mm and 25mm
5. CODE: HCSETB | 4 piece brass hose fitting set; for 12mm hose
6. CODE: SH25NT | Nut & tail, 25mm
7. CODE: SH32NT | Nut & tail, 32mm
8. CODE: SH38NT | Nut & tail, 38mm
9. CODE: SH25J | Joiner, 25mm
10. CODE: SH32J | Joiner, 32mm
11. CODE: SH38J | Joiner, 38mm
12. CODE: SH1425D | Director, 14mm/25mm
13. CODE: SH25D | Director, 25mm
14. CODE: SH32D | Director, 32mm
15. CODE: SH38D | Director, 38mm
16. CODE: SH4020RN | Reducing nipple, 40mm/20mm
17. CODE: SH4025RN | Reducing nipple, 40mm/25mm
18. CODE: SH4032RN | Reducing nipple, 40mm/32mm
19. CODE: SH4020RB | Reducing bush, 40mm/20mm
20. CODE: SH4025RB | Reducing bush, 40mm/25mm
21. CODE: SH4032RB | Reducing bush, 40mm/32mm
22. CODE: HCATA | American thread adaptor, 1 1/16"
23. CODE: SHDC25 | Dust cap to suit 25mm tube
24. CODE: SHCAM | CAM fitting, fits 25mm - 38mm
25. CODE: SHCAMP | Male fitting to suit SHCAM



DRINKING WATER HOSE STORAGE BAG

CODE: SHB

- To suit up to 10m of drinking water hose

Dimensions:
340mm dia.



SULLAGE HOSE STORAGE BAG

CODE: LHB

- To suit up to 10m of sullage hose

Dimensions:
480mm dia.



ELECTRICAL LEAD STORAGE BAG

CODE: LB10

- To suit up to 20m of extension lead

Dimensions:
340mm dia.



STORAGE BAG SET

CODE: HB3PK

- Includes 1 x Drinking Water Hose Storage Bag,
1 x Sullage Hose Storage Bag
and
1 x Electrical Lead Storage Bag





PLASTIC FIXED CARAVAN STEP

CODE: STP2

- Durable plastic fixed step
- Weight Rating: 80kg

Dimensions: 345mm (d) x 500mm (w) x 230mm (h)



METAL CARAVAN STEP

CODE: STP3

- Metal frame with folding legs
- Non-slip tread
- Weight Rating: 150kg

Dimensions: 300mm (d) x 480mm (w) x 220mm (h)



ALUMINIUM CARAVAN STEP, BLACK

CODE: STP3B

- Black aluminium frame with folding legs
- With luminous strip & non-slip tread
- Weight Rating: 150kg

Dimensions: 300mm (d) x 480mm (w) x 220mm (h)



HEAVY DUTY ADJUSTABLE STEP

CODE: STP4

- Heavy duty steel frame with folding legs
- Non-slip tread
- Four stage height adjustment, up to 220mm high

- Weight Rating: 300kg
Dimensions: 370mm (d) x 480mm (w) x 220mm (h)



TWO STAGE ALUMINIUM STEP

CODE: STP6

- Two stage step, folds flat for easy storage
 - Weight Rating: 150kg
- Step Dimensions: 225mm (d) x 350mm (w)
Overall Height: 380mm
Lower Step Height: 180mm



TWO STAGE ALUMINIUM STEP, BLACK

CODE: STP6B

- Black two stage step, folds flat for easy storage, with luminous strip
 - Weight Rating: 150kg
- Step Dimensions: 225mm (d) x 350mm (w)
Overall Height: 380mm | Lower Step Height: 180mm



TWO STAGE FOLDING STEP

CODE: DBSP

- Two stage folding step with zinc finish
 - Weld or bolt on to caravan or camper trailer
 - Unit weight: 11kg | Weight Rating: 150kg
- Open Dimensions: 750mm (d) x 535mm (w) x 180mm (h)
Closed Dimensions: 300mm (d) x 535mm (w) x 180mm (h)

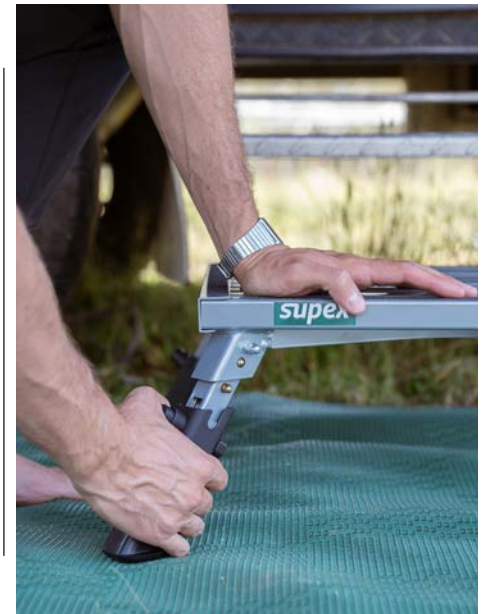

MAGAZINE HOLDER

CODE: MGZH

- Storage solution for magazines and books
- Fastens onto the back of RV shelving
- Plastic frame with 5mm dia. elastic rope
- Screws included

Dimensions:
355mm (w) x 185mm (h)

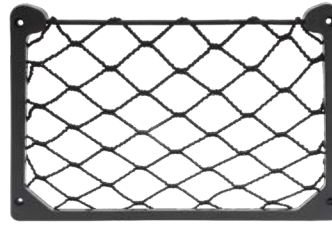

T-LEVEL

CODE: CL1

- Made from UV resistant high impact plastic
- Comes in a hang sell pack

Dimensions:
60mm (l) x 45mm (w) x 15mm (d)



CARAVAN SINK PLUG

CODE: SRCSP25

- Made from soft rubber

Dimensions:
25mm dia.

HANG SELL AVAILABLE



CARAVAN WATER FILTER

CODE: SRCR20

- Portable caravan inline water filter with brass hose connectors for caravan or motor home
- Inhibits bacteria growth and removes unwanted taste, odours and chemicals

Specifications:

Rating: 1 micron

Dimensions: 70mm (dia.) x 300mm (h)

Connection: garden hose 1/2"

Min/max hose flow: 0 - 20 litres per minute

Min/max temperature: 2° - 38°

Min/max pressure: 200 - 860 kPa



SINK HAND PUMP

CODE: SHP1

- Double action manual pump operation for water on up and down strokes
- Self priming, releases water at any time
- Manufactured from corrosion resistant nylon with polyurethane interior seals and an anodised aluminium barrel
- Includes bonus repair kit

Specifications:

Pump extends 97mm above bench top

Spout extends 140mm from centreline of pump

Maximum bench thickness - 25mm

Bench top to hose fitting distance - 185mm





ROUND CONTAINERS, 4PK

CODE: CLP6

- Set of four collapsible round containers
- Dishwasher safe
- 100% food grade silicone, BPA-free, non-toxic and odourless
- FDA and LFGB approved
- Collapsed height: 120mm stacked

400mL - 120mm (dia.) x 64mm (h)
 600mL - 140mm(dia) x 64mm (h)
 880mL - 160mm (dia.) x 69mm (h)
 1250mL - 190mm (dia.) x 74mm (h)



RECTANGLE CONTAINERS, 4PK

CODE: CLP12

- Set of four collapsible rectangular containers
- Dishwasher safe
- 100% food grade silicone, BPA-free, non-toxic and odourless
- FDA and LFGB approved
- Collapsed height: 120mm stacked

350mL - 83mm (d) x 118mm (w) x 64mm (h)
 540mL - 93mm (d) x 151mm (w) x 64mm (h)
 800mL - 107mm (d) x 172mm (w) x 64mm (h)
 1200mL - 122mm (d) x 210mm (w) x 74mm (h)



DISH DRAINER

CODE: CLP1

- Made from silicone and plastic

Dimensions: 315mm (d) x 365mm (w) x 125mm (h)
 Collapsed height: 50mm



DOUBLE HANDLE COLANDER

CODE: CLP29 | BLUE
 CODE: CLP30 | GREY

- Dishwasher safe
- Can be used as a steamer, fits inside 1.5L collapsible saucepan

Dimensions: 200mm (dia.) x 85mm (h)
 Collapsed height: 35mm



COLLAPSIBLE BOWL

CODE: CLP2

- Collapsible bowl for multi-purpose use

Dimensions: 380mm (dia.) x 160mm (h)
Collapsed height: 50mm



COLLAPSIBLE KETTLE

CODE: CLP19 | BLUE
CODE: CLP20 | GREY

- Collapsible, dishwasher safe kettle for use on stovetop, hob or cooker
 - Made from stainless steel, silicone and PA
 - Collapsed height: 50mm
- Note: Not suitable for induction cooktops

Volume: 1.2L
Dimensions: 70mm (d) x 195mm (w) x 225mm (h)



COLLAPSIBLE SAUCEPAN

CODE: CLP13 | Blue, 1L. 160mm (dia.) x 90mm (h) - open
CODE: CLP14 | Blue, 1.5L. 200mm (dia.) x 85mm (h) - open
CODE: CLP15 | Blue, 3L. 240mm (dia.) x 125mm (h) - open
CODE: CLP16 | Grey, 1L. 160mm (dia.) x 90mm (h) - open
CODE: CLP17 | Grey, 1.5L. 200mm (dia.) x 85mm (h) - open
CODE: CLP18 | Grey, 3L. 240mm (dia.) x 125mm (h) - open

- Collapsible, dishwasher safe saucepan for use on stovetop, hob or cooker with anti-slip lid edge design
 - Made from stainless steel, silicone and glass
 - Collapsed height: 50mm
- Note: Not suitable for induction cooktops



COLLAPSIBLE FRYPAN

CODE: CLP31 | BLUE
CODE: CLP32 | GREY

- Collapsible frying pan for use on stovetop, hob or cooker
 - Non-stick stainless steel surface with folding handle
 - Collapsed height: 58mm
- Note: Not suitable for induction cooktops

Dimensions: 240mm (dia.) x 85mm (h) - open

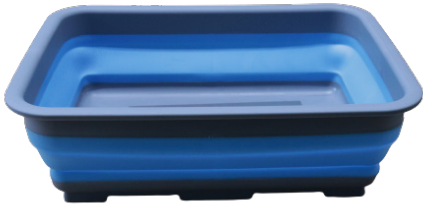

RECTANGLE DISH

CODE: CLP3

Dimensions:
270mm (d) x 370mm (w) x 120mm (h)

Collapsed height: 50mm



RECTANGLE DISH WITH HANDLES

CODE: CLP9

Dimensions:
285mm (d) x 380mm (w) x 140mm (h)

Collapsed height: 50mm



BUCKET

CODE: CLP4

Dimensions:
330mm (dia.) x 250mm (h)

Collapsed height: 50mm



WASH TUB / SINK

CODE: CLP7

- With draining hole

Dimensions:
300mm (d) x 320mm (w) x 175mm (h)
Collapsed height: 50mm



SMALL BASKET

CODE: CLP8

Dimensions:
375mm (d) x 500mm (w) x 205mm (h)
Collapsed height: 60mm

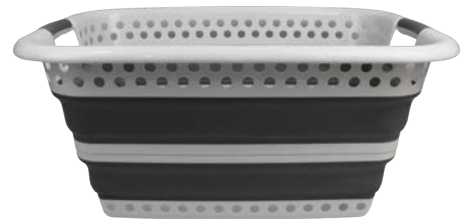

LARGE BASKET

CODE: CLP28

Dimensions:
460mm (d) x 610mm (w) x 270mm (h)
Collapsed height: 85mm

POLE CARRIER

CODE: PC160 | 150MM (DIA.) X 1.60M (L) | WHITE
 CODE: PC180 | 150MM (DIA.) X 1.80M (L) | WHITE
 CODE: PC200 | 150MM (DIA.) X 2.00M (L) | WHITE
 CODE: PC220 | 150MM (DIA.) X 2.20M (L) | WHITE

CODE: PC160B | 150MM (DIA.) X 1.60M (L) | BLACK
 CODE: PC180B | 150MM (DIA.) X 1.80M (L) | BLACK
 CODE: PC200B | 150MM (DIA.) X 2.00M (L) | BLACK
 CODE: PC220B | 150MM (DIA.) X 2.20M (L) | BLACK

- Heavy duty plastic pole holder for tent poles, anti-flap kits and fishing rods
- Easily lockable on both ends; remove the Quik clips and add padlocks
- Can be fitted to caravan chassis or vehicle roof rack
- Mounting brackets included
- White Pole Carrier made from UPVC / Black Pole Carrier made from HDPE
- Four sizes and two colours available



MOUNTING BRACKETS

CODE: PCMBS

- Bolt on mounting brackets for pole carrier
- Suitable for up to 150mm chassis of caravan or camper trailer
- Suits 150mm dia. pole carrier
- Made from zinc plated steel
- Sold as a pair



PVC FOAM CARPET

CODE: FC3B | BLUE | 2.50M X 3.00M
 CODE: FC4B | BLUE | 2.50M X 4.00M
 CODE: FC5B | BLUE | 2.50M X 5.00M
 CODE: FC6B | BLUE | 2.50M X 6.00M

CODE: FC3GN | GREEN | 2.50M X 3.00M
 CODE: FC4GN | GREEN | 2.50M X 4.00M
 CODE: FC5GN | GREEN | 2.50M X 5.00M
 CODE: FC6GN | GREEN | 2.50M X 6.00M

CODE: FC3GY | GREY | 2.50M X 3.00M
 CODE: FC4GY | GREY | 2.50M X 4.00M
 CODE: FC5GY | GREY | 2.50M X 5.00M
 CODE: FC6GY | GREY | 2.50M X 6.00M

Premium quality, heavy duty PVC foam carpet for use under caravan and camper trailer annexes. The design provides comfort underfoot and allows sand and dirt to fall through whilst ensuring minimal damage to grass underneath.

- Low maintenance; shake and wipe clean
- Water, dirt & sand draining
- UV treated, lightweight & soft to touch
- Breathable 550GSM PVC foam
- Includes carry bag



MESH GROUND MATTING

CODE: MGM8X8 | 8ft (w) x 8ft (l) | 2.40m (w) x 2.40m (l)
 CODE: MGM10X10 | 10ft (w) x 10ft (l) | 3.00m (w) x 3.00m (l)
 CODE: MGM10X20 | 10ft (w) x 20ft (l) | 3.00m (w) x 6.00m (l)
 CODE: MGM12X12 | 12ft (w) x 12ft (l) | 3.70m (w) x 3.70m (l)

Economy mesh ground matting for use under gazebos. Mesh-style matting allows the grass underneath to breathe whilst providing protection underfoot.

- Reinforced with eyelets at 80cm intervals
- Can be used for under-tent floor saver
- UV stabilised
- Manufactured from 180GSM shade cloth
- Includes carry bag



EASY HANG CLOTHESLINE

CODE: CLSS8 | To suit 8' awning
CODE: CLSS9 | To suit 9' awning
CODE: CLSS10 | To suit 10' awning
CODE: CLSS11 | To suit 11' awning
CODE: CLSS12 | To suit 12' awning
CODE: CLSS13 | To suit 13' awning
CODE: CLSS14 | To suit 14' awning
CODE: CLSS15 | To suit 15' awning
CODE: CLSS16 | To suit 16' awning
CODE: CLSS17 | To suit 17' awning
CODE: CLSS18 | To suit 18' awning
CODE: CLSS19 | To suit 19' awning
CODE: CLSS20 | To suit 20' awning
CODE: CLSS21 | To suit 21' awning
CODE: CLSS22 | To suit 22' awning
CODE: CLSS23 | To suit 23' awning
CODE: CLSS24 | To suit 24' awning
CODE: CLSS25 | To suit 25' awning

- Stainless steel easy hang clothesline
- Includes one line per pack



FOLDING CLOTHES AIRER

CODE: CD2

- Strong, lightweight aluminium frame with tri-leg design for maximum stability
- Collapsible for easy transportation
- Includes carry bag and ground pegs

Dimensions:

Diagonal: 150cm x 150cm (w)

Legs: 96cm (w) / Assembled: 140 - 145cm (h)



CARAVAN AWNING & ACCESSORIES



POWDERCOATED ALUMINIUM CURVED ROOF RAFTER

WHITE:

CODE: 563V | SLIGHT CURVE, MAX. LENGTH: 243CM (8FT)
 CODE: 563VA | ACUTE CURVE, MAX. LENGTH: 243CM (8FT)

BLACK:

CODE: 563VB | SLIGHT CURVE, MAX. LENGTH: 243CM (8FT)
 CODE: 563VAB | ACUTE CURVE, MAX. LENGTH: 243CM (8FT)

- All models available with clip ends on request

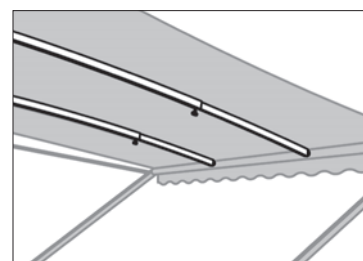

SLIGHT CURVE, WHITE

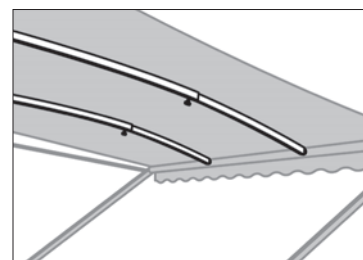

ACUTE CURVE, WHITE

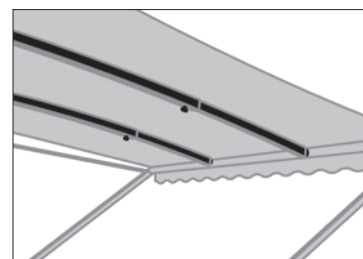

SLIGHT CURVE, BLACK

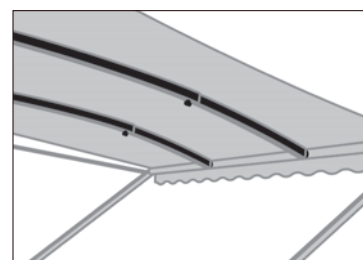

ACUTE CURVE, BLACK

SECURA BAR KITS (ANTI-FLAP KITS)

WHITE:

CODE: ASWS | SMALL, EXTENDABLE LENGTH: 210CM - 220CM
CODE: ASWM | MEDIUM, EXTENDABLE LENGTH: 220CM - 230CM
CODE: ASWL | LARGE, EXTENDABLE LENGTH: 230CM - 240CM

BLACK:

CODE: ASBS | SMALL, EXTENDABLE LENGTH: 210CM - 220CM
CODE: ASBM | MEDIUM, EXTENDABLE LENGTH: 220CM - 230CM
CODE: ASBL | LARGE, EXTENDABLE LENGTH: 230CM - 240CM

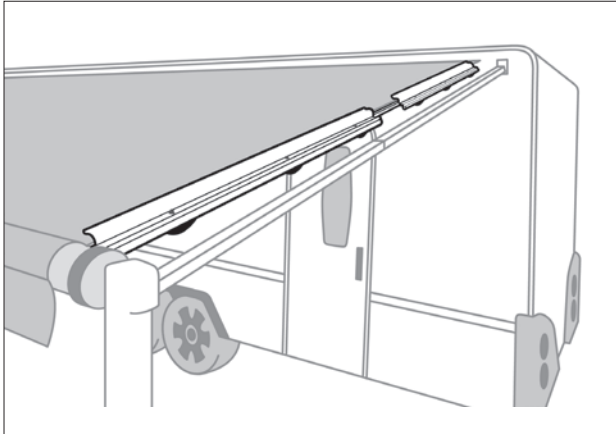

SECURA BAR, WHITE

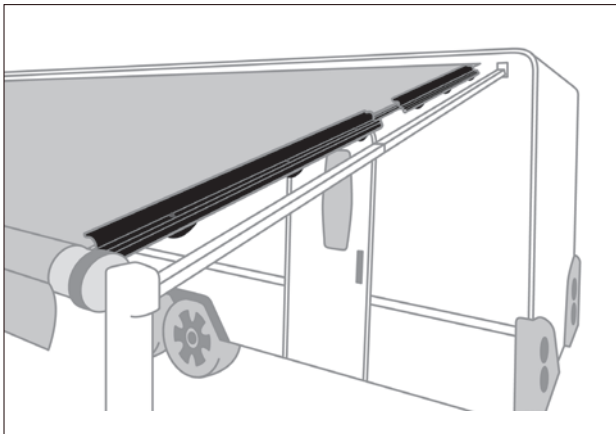

SECURA BAR, BLACK

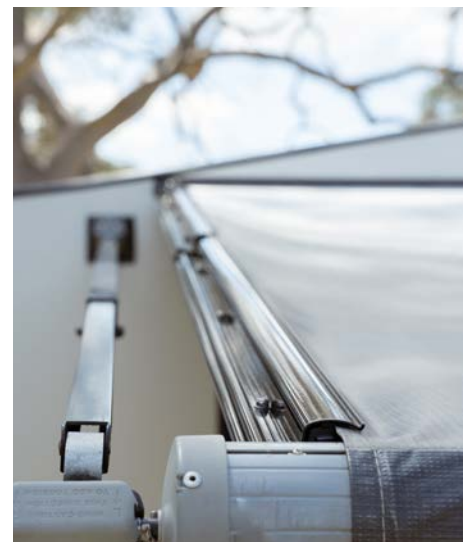



SECURA BAR / CURVED ROOF RAFTER STORAGE BAG

CODE: ASCB

- Six pockets to fit 1 x Secura Bar anti-flap kit set and 2 x Curved Roof Rafter
 - Manufactured from polypropylene
- Dimensions:
1530mm (l) x 630mm (w)



CURVED ROOF RAFTER END

CODE: 563RE

- Stainless steel roof rafter end
- Also suits Supex Secura Bar



CURVED ROOF RAFTER TURNING KNOB

CODE: 563TS

- Black plastic turning knob
- To suit Curved Roof Rafter



CURVED ROOF RAFTER SPIGOT END

CODE: 563SP

- Steel spigot end, moulded black plastic base



SECURA BAR EXTENSION

CODE: ASEW | WHITE | SET OF 2
CODE: ASEB | BLACK | SET OF 2

- Extend Secura Bar to be usable on box and cassette style awnings
 - Remove the existing hook, then slide the extension piece in
- Dimensions: 100mm (l)



SECURA BAR TURNING KNOB

CODE: ASTK

- Replacement turning knob to suit Supex Secura Bar



AWNING ADAPTOR BRACKET

CODE: 38T

- Adaptor bracket to attach your Secura Bar or Curved Roof Rafter to box / cassette style awning
- Attach bracket to lead rail of awning with screws or rivets



SECURA BAR SPIGOT END

CODE: ASSP

- Steel spigot end to suit Supex Secura Bar



SECURA BAR HANDLE

CODE: ASHA

- Plastic handle assembly to tighten Supex Secura Bar



LARGE CARAVAN AWNING TENSIONER

CODE: SRDF1

- Suits most caravan and pop top style awning systems
- Pack includes one tensioner, one 600mm strap and one 300mm strap
- Dimensions: 50mm (d) x 200mm (w)



AWNING BRACKET

CODE: 38AB

- Pole clip for roll out awnings
- Suits Carefree, A&E & Dometic awnings; not suitable for Fiamma awnings

Dimensions: 38mm x 40mm (10mm dia slot for tent poles, 8mm dia. round rod)



CARAVAN AWNING SAFETY STRAPS

CODE: CASS

- Velcro caravan awning safety straps
- Secure awning arms whilst travelling
- Pack of two



POP TOP SUPPORT BAR

CODE: PTS | 22-25MM DIA. X 1.2WT WHITE FINISH | EXTENDS TO 50CM

CODE: PTS2 | 22-25MM DIA. X 1.2WT WHITE FINISH | EXTENDS TO 60CM

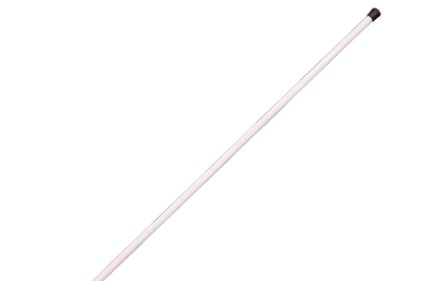

POP TOP SUPPORT BAR, JAYCO

CODE: PTSJ | TO SUIT JAYCO VAN | 22MM DIA. X 1200MM (L)



POP TOP SUPPORT DISPLAY BOX

CODE: PTSDB

- Cardboard display box
- Includes 14 x PTS



RUBBER LADDER STRAP

CODE: ANLADD

- Makes tying down annexes easy
- Multiple 'steps' in ladder allow for varying tie-down positions
- Dimensions: 225mm (l) x 22mm (w)



AWNING CENTRE SUPPORT CRADLE

CODE: WACS | WHITE
CODE: BACS | BLACK

- Support the centre weight of any roll out awning whilst travelling
- Box includes: 1 x back panel, 1 x arm, 1 x cradle support, screw set



AWNING ROPE CLIPS

CODE: ARC

- Caravan awning rope clips to fit most Dometic (A&E), Carefree and Aussie Traveller awnings
- Stainless steel
- Hang sell pack of two, available to buy in bulk

AWNING ROPE CLIP PACK

CODE: ARCPK

- Basic awning set up rope clip pack

Contains:

- Two guy ropes, two awning rope clips, two tent pegs

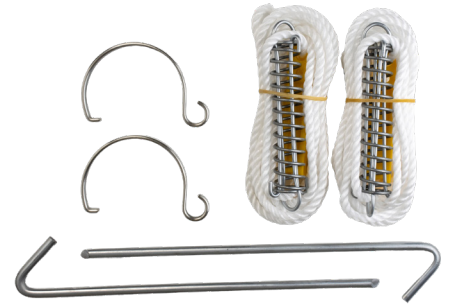

12V AWNING ROPE CRADLE

CODE: ARCV

- Awning rope cradles to suit Carefree 12V roll out awning



12V AWNING ROPE CRADLE BOX PACK

CODE: ARCVBP

- Basic set up cradle pack to suit Carefree 12V roll out awning

Contains:

- Two cradles, two ground plates, two guy ropes, six tent pegs

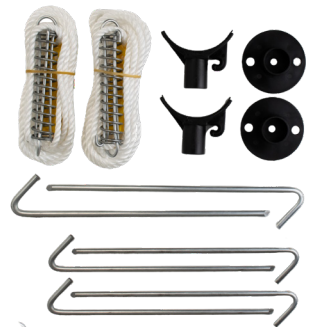

12V AWNING ROPE CRADLE POLE PACK, WHITE

CODE: ARCVPP

- Complete set cradle pack to suit Carefree 12V roll out awning

Contains:

- Two cradles, two large bow mounts, two guy ropes, six tent pegs, two white 9ft aluminium poles



12V AWNING ROPE CRADLE POLE PACK, BLACK

CODE: ARCVPPB

- Complete set cradle pack to suit Carefree 12V roll out awning

Contains:

- Two cradles, two large bow mounts, two guy ropes, six tent pegs, two black 9ft aluminium poles



LONG WALL PRIVACY SCREEN, GREY

CODE: SRPS28 | 2.80M (L) X 1.80M (H) | SUITS 10' AWNING
CODE: SRPS34 | 3.40M (L) X 1.80M (H) | SUITS 12' AWNING
CODE: SRPS37 | 3.70M (L) X 1.80M (H) | SUITS 13' AWNING
CODE: SRPS40 | 4.00M (L) X 1.80M (H) | SUITS 14' AWNING
CODE: SRPS42 | 4.26M (L) X 1.80M (H) | SUITS 15' AWNING
CODE: SRPS46 | 4.60M (L) X 1.80M (H) | SUITS 16' AWNING
CODE: SRPS48 | 4.87M (L) X 1.80M (H) | SUITS 17' AWNING
CODE: SRPS52 | 5.20M (L) X 1.80M (H) | SUITS 18' AWNING
CODE: SRPS55 | 5.50M (L) X 1.80M (H) | SUITS 19' AWNING

- Long wall privacy screen made to suit the Australian environment
- Shade rating: 95%, made from 199GSM fabric
- Four year warranty
- Includes guy ropes, tent pegs and D-rings
- 6mm spline



LONG WALL PRIVACY SCREEN, BLACK

CODE: SRPS28B | 2.80M (L) X 1.80M (H) | SUITS 10' AWNING
CODE: SRPS34B | 3.40M (L) X 1.80M (H) | SUITS 12' AWNING
CODE: SRPS37B | 3.70M (L) X 1.80M (H) | SUITS 13' AWNING
CODE: SRPS40B | 4.00M (L) X 1.80M (H) | SUITS 14' AWNING
CODE: SRPS42B | 4.26M (L) X 1.80M (H) | SUITS 15' AWNING
CODE: SRPS46B | 4.60M (L) X 1.80M (H) | SUITS 16' AWNING
CODE: SRPS48B | 4.87M (L) X 1.80M (H) | SUITS 17' AWNING
CODE: SRPS52B | 5.20M (L) X 1.80M (H) | SUITS 18' AWNING
CODE: SRPS55B | 5.50M (L) X 1.80M (H) | SUITS 19' AWNING

- Long wall privacy screen made to suit the Australian environment
- Shade rating: 95%, made from 199GSM fabric
- Four year warranty
- Includes guy ropes, tent pegs and D-rings
- 6mm spline



BONUS DROP PRIVACY SCREEN, 1.95M DROP

CODE: SRPSBD37 | 3.70M (L) X 1.95M (H) | SUITS 13' AWN.
 CODE: SRPSBD40 | 4.00M (L) X 1.95M (H) | SUITS 14' AWN.
 CODE: SRPSBD42 | 4.26M (L) X 1.95M (H) | SUITS 15' AWN.
 CODE: SRPSBD46 | 4.60M (L) X 1.95M (H) | SUITS 16' AWN.
 CODE: SRPSBD48 | 4.87M (L) X 1.95M (H) | SUITS 17' AWN.
 CODE: SRPSBD52 | 5.20M (L) X 1.95M (H) | SUITS 18' AWN.
 CODE: SRPSBD55 | 5.50M (L) X 1.95M (H) | SUITS 19' AWN.

- Bonus drop side wall privacy screen to suit off road caravans
- Shade rating: 95%, made from 199GSM fabric
- Four year warranty
- Includes guy ropes, tent pegs & D-rings
- 6mm spline



supex

END WALL CARAVAN PRIVACY SCREEN

CODE: CAEPS | GREY | 1.9M (W) X 2.3M (HIGH END)
 X 2.1M (LOW END)

CODE: CAEPSB | BLACK | 1.9M (W) X 2.3M (HIGH
 END) X 2.1M (LOW END)

CODE: CAEPSBD | END W. | 2.0M (W) X 2.5M
 (HIGH) X 2.1M (LOW)

- End wall privacy screen
- 4 year warranty
- Shade rating: 95%, made from 199GSM fabric
- Includes guy ropes, tent pegs and D-rings
- 6mm spline



AWNING PORCH EXTENSION KIT

CODE: W5000P

- Extends awning space of any caravan setup
- Velcro straps and Kedar splines run along top, easily attach privacy screen to awning arms
- Made from 560GSM fabric
- Includes guy ropes, tent pegs and tent poles
- 6mm spline

Dimensions:

2100mm (w) x 1800mm (drop) x 1550mm (extension)



POP TOP CARAVAN END WALL

CODE: PTAEPS | GREY | 2.05M (W) X 1.85M (H)
 CODE: PTAEPSB | BLACK | 2.05M (W) X 1.85M (H)

- Shade rating: 95%
- Manufactured from 199GSM fabric
- Four year warranty
- Includes guy ropes, tent pegs & D-rings

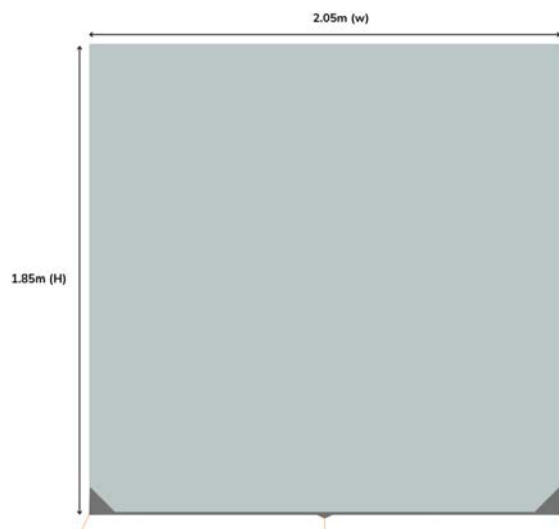

FIAMMA AWNING PRIVACY SCREEN (4MM SPLINE)

CODE: SRPSF28 | LONG WALL | 2.85M (L) X 1.80M (H) | SUITS 3.00M FIAMMA F45 AWNING
 CODE: SRPSF33 | LONG WALL | 3.35M (L) X 1.80M (H) | SUITS 3.50M FIAMMA F45 AWNING
 CODE: SRPSF38 | LONG WALL | 3.85M (L) X 1.80M (H) | SUITS 4.00M FIAMMA F45 AWNING
 CODE: CAEPSF | END WALL | SUITS FIAMMA F45 AWNING

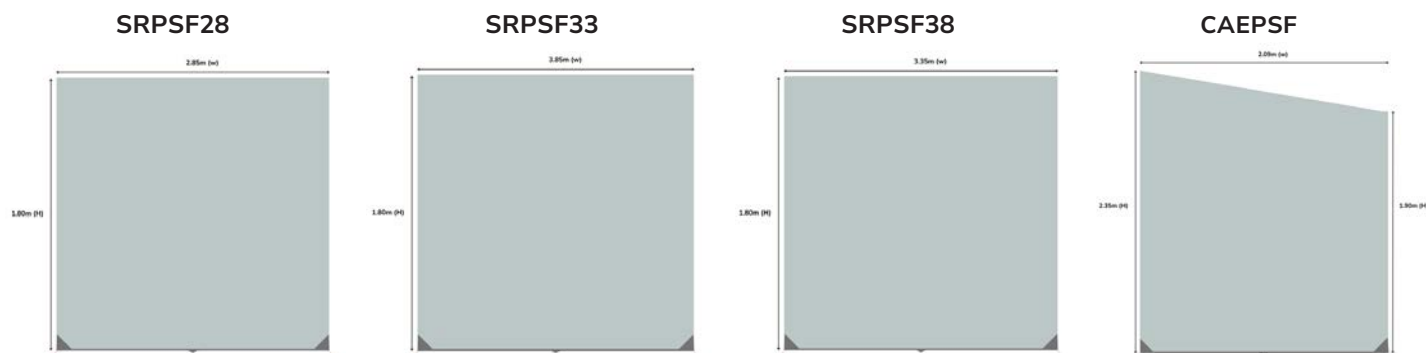

TIE DOWN KIT

CODE: CAM1

- Quickly and easily fasten privacy screens
- Provides tension
- For tarps, tents and more

Includes:

- 5 x bungee cords, 5 x tent pegs

Tent Peg Dimensions: 6.3mm (dia.) x 225mm (h)



ENSUITE





PORTA PAK FRESH SCENT

CODE: WL1

- Odour prevention
- Biodegradable & formaldehyde free
- Pack of 15 sachets



PORTA PAK LAVENDAR BREEZE

CODE: WL2

- Odour prevention
- Biodegradable & formaldehyde free
- Pack of 15 sachets



PORTA PAK ALPINE FRESH

CODE: WL3

- Removes odours, safe for septic tank
- Biocide & formaldehyde free
- 100% biodegradable
- Pack of 15 sachets



BIO PACK TROPICAL BREEZE

CODE: WL4

- Removes odours, safe for septic tank
- Biocide & formaldehyde free
- Pack of 15 sachets



WALEX COMMANDO

CODE: WL5

- Lubricates valves & seals
- Septic tank safe, dissolvable packet
- Formaldehyde free & eco-friendly
- Pack of 4 sachets



WALEX ELEMONATE

CODE: WL6

- Cleans sensors inside grey tank
- Dissolves rapidly
- Biodegradable & formaldehyde free
- Pack of 5 sachets

CAMP BLUE LIQUID

CODE: STCB | 2.5L
CODE: STCB1L | 1L

- High concentrate toilet liquid
- For use in the waste tank of all chemical toilets
- Prevents gas build up
- Eliminates unpleasant odours and leaves a fresh scent
- Dilution rate of 100ml per 20 litres of waste tank capacity
- Made in the Netherlands



CAMP FLUSH LIQUID

CODE: STCF | 2.5L
CODE: STCF1L | 1L

- Pleasant smelling toilet break down liquid
- For use in the flush tank of all chemical toilets,
- Environmentally safe & biodegradable
- Protects and lubricates toilet seals
- Helps prevent scaling
- Dilution rate of 80ml per 15 litres of fresh water
- Made in the Netherlands



CAMP GREEN LIQUID

CODE: STCG | 2.5L
CODE: STCG1L | 1L

- High concentrate toilet liquid
- For use in the waste tank of all chemical toilets
- Environmentally safe & biodegradable
- Prevents gas build up
- Eliminates unpleasant odours and leaves a fresh scent
- Dilution rate of 100ml per 20 litres of waste tank capacity
- Made in the Netherlands



CAMP SOFT TOILET PAPER

CODE: STICS

- Rapidly dissolving toilet paper
- For all types of portable toilets
- Pack of 4 rolls



WATER TANK CLEANER

CODE: SWC

- Environmentally friendly concentrate for caravan pipes and water tanks
- Cleans limescale and deposits
- Contains 500mL



CASSETTE TANK CLEANER

CODE: SCTC

- High concentrate cleaning liquid
- For use in the waste tank of chemical and/or portable toilets
- Contains 1L



ELECTRICAL & 12V





ANODE

CODE: AND1 | BULK
CODE: AND1P | HANG SELL PACK

- Magnesium caravan hot water service replacement anode

Dimensions: 21mm dia. x 300mm (l)



7 PIN FLAT PLUG

CODE: EAP7F

- Circuits engraved into outer casing
- Saddle device to secure wiring
- Seven pins rated at 15amps at 12V
- Suitable for 12V and 24V applications



7 PIN FLAT SOCKET

CODE: EA7FFM

- Circuits engraved into outer casing
- Seven pins rated at 15amps at 12V
- Suitable for 12V and 24V applications



ELECTRICAL LEADS

CODE: EL10 | 10m length
CODE: EL15 | 15m length
CODE: EL20 | 20m length

- Heavy duty caravan extension lead, 15amp plug



HAIR DRYER

CODE: HDYR

- Convenient, compact hair dryer for travelling
- Hot and cool air options
- DC motor; 12V car use voltage, 50Hz, 192W
- Includes 1.5m PVC cord



HAIR STYLER

CODE: HRST

- Convenient hair styler for travelling
- Ceramic plate & PTC heater, heats rapidly to max. 200°
- LED light indicates ready for use
- 12V car use voltage

12V/24V CARAVAN INTERIOR FAN, WHITE

CODE: SCF12-W

- Remote control or manual control
- Light display to show fan speed and time functions
- Minimal noise and low amp draw
- 180 degrees swivel head design with locking tab
- 360 degrees airflow
- Three fan speeds: low, medium & high
- Four preset timer settings: 3,6,9 & 12 hours
- Weight: 700g

Dimensions: 350mm (h) x 250mm (w) x 95mm (d)

NEW!



12V/24V CARAVAN INTERIOR FAN, BLACK

CODE: SCF12-B

- Remote control or manual control
- Light display to show fan speed and time functions
- Minimal noise and low amp draw
- 180 degrees swivel head design with locking tab
- 360 degrees airflow
- Three fan speeds: low, medium & high
- Four preset timer settings: 3,6,9 & 12 hours
- Weight: 700g

Dimensions: 350mm (h) x 250mm (w) x 95mm (d)

NEW!





A LIFETIME OF ADVENTURE



60MM CARAVAN READING LIGHT

CODE: BCRL1

- Matte black finish with frosted glass
 - Touch switch
 - Swivel joint
 - 60mm dia. base
 - 10-15DC, LED, 2W, 6000K
- Light modes:
- Cool white

NEW!



60MM CARAVAN READING LIGHT

CODE: BCRL2

- Matte black finish
 - Rocker switch
 - Swivel joint
 - 60mm dia. base
 - 10-15DC, LED, 2W, 6000K
 - USB-C 5V 2.1A
- Light modes:
- Cool white

NEW!



60MM CARAVAN READING LIGHT

CODE: BCRL3

- Matte black finish
 - Rocker switch
 - Swivel joint
 - 60mm dia. base
 - 10-15DC, LED, 2W, 6000K
- Light modes:
- Cool white

NEW!



BLUE NIGHT LIGHT

60MM CARAVAN READING LIGHT

CODE: BCRL5

- Matte black finish with flexible silicone arm
 - Touch switch
 - 60mm dia. base
 - 10-15DC, LED, 2W, 6000K
 - USB-C 5V 2.1A
- Light modes:
- Cool white
 - Blue night light

NEW!



BLUE NIGHT LIGHT

FAUX TIMBER READING LIGHT

CODE: SFL1

- Faux timber finish with extra long flexible silicone arm
 - Dimmable touch switch
 - 60mm dia. base
 - 10-15V DC, SMD LED, 2W (0.2W for night light), 6000K
 - USB-C 5V 2.1A
- Light modes:
- Cool white (dimnable when switch is pressed continuously)
 - Blue night light

NEW!



BLUE NIGHT LIGHT

EXTRA LONG READING LIGHT

CODE: SFL3

- Matte black finish with extra long flexible silicone arm
 - Dimmable touch switch
 - 60mm dia. base
 - 10-15V DC, SMD LED, 2W (0.2W for night light), 6000K
 - USB-C 5V 2.1A
- Light modes:
- Cool white (dimnable when switch is pressed continuously)
 - Blue night light

NEW!



BLUE NIGHT LIGHT

80MM CARAVAN READING LIGHT

CODE: BNL1

- Matte black finish with flexible silicone arm
- Dimmable touch switch
- 80mm dia. base
- 10-15V DC, SMD LED, 0.2W-2W, 6000K
- USB-C 5V 2.1A
- Cool white (dimmmable)
- Blue night light

NEW!



BLUE NIGHT LIGHT

80MM CARAVAN READING LIGHT

CODE: BNL2

- Matte black finish with flexible silicone arm
- Dimmable touch switch
- 80mm dia. base
- 10-15V DC, SMD LED, 0.2W-2W, 6000K
- USB-C 5V 2.1A
- Cool white (dimmmable)
- Blue night light

NEW!



BLUE NIGHT LIGHT

80MM CARAVAN READING LIGHT

CODE: BNL3

- Matte black finish with flexible silicone arm
- Dimmable touch switch
- 80mm dia. base
- 10-15V DC, SMD LED, 0.2W-2W, 6000K
- USB-C 5V 2.1A
- Cool white (dimmmable)
- Blue night light

NEW!



BLUE NIGHT LIGHT

80MM CARAVAN READING LIGHT

CODE: BNL4

- Matte black finish with flexible silicone arm
- Dimmable touch switch
- 80mm dia. base
- 10-15V DC, SMD LED, 0.2W-2W, 6000K
- USB-C 5V 2.1A
- Cool white (dimmmable)
- Blue night light

NEW!



76MM CARAVAN CEILING LIGHT - WHITE

CODE: CL76-W

- 12V, 3W, 360lm
- Max draw: 0.29A
- Light mode: Cool white
- 76mm dia.

NEW!

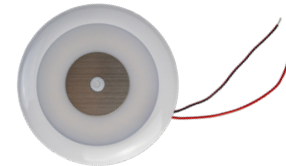

TRI-COLOUR CEILING LIGHT - WHITE

CODE: CL126-W

- Switch & memory function
- IP67 waterproof rating
- Fully UV stabilised
- 10-30V, 3W (single) 7W (dual)
- AMP draw range: 0.21A - 1.06a
- Light modes: Cool white, amber light, day light (all dimmmable)
- 126mm dia.

NEW!



DUAL COLOUR AWNING LIGHT - 255MM

CODE: EBL25-W | WHITE FINISH
CODE: EBL25-B | BLACK FINISH

- Switch & memory function
- IP66 waterproof rating
- Fully UV stabilised
- 10-30V, 18AWG wire. AMP draw range: 0.10A - 0.65A
- Cool white (dimmmable)
- Amber light (dimmmable)

NEW!



DUAL COLOUR AWNING LIGHT - 550MM

CODE: EBL55-W | WHITE FINISH
CODE: EBL55-B | BLACK FINISH

- Switch & memory function
- IP66 waterproof rating
- Fully UV stabilised
- 10-30V, 18AWG wire. AMP draw range: 0.28A - 0.65A
- Cool white (dimmmable)
- Amber light (dimmmable)

NEW!



OYSTER LIGHT

CODE: SRLED1

- 12V interior roof mount light
- Body colour: white
- Cool white light, 6W

Dimensions: 260mm dia.



ULTRA SLIM LIGHT

CODE: SRLED5 | 127MM DIA.
CODE: SRLED27 | 216MM DIA.

- Opal panel light with switch
- Body colour: white



READING LIGHT

CODE: SRLED2

- LED frosted glass swivel light

Dimensions:
106mm (h)



READING LIGHT

CODE: SRLED15B | 160MM (H)
CODE: SRLED15C | 139MM (H)

- 10-15V programmed reading light
- Crystal glass flexible light
- Dual colour - cool white, blue

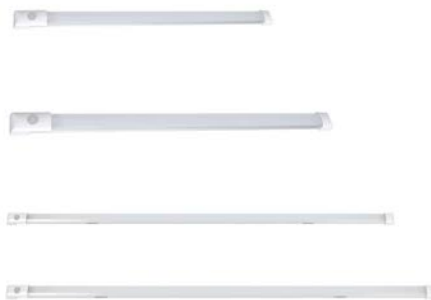

BRIGHT BAR LIGHT

CODE: SRLED22 | 150MM (L) X 21MM (W) X 12MM (D)
CODE: SRLED23 | 300MM (L) X 21MM (W) X 12MM (D)
CODE: SRLED24 | 450MM (L) X 21MM (W) X 12MM (D)
CODE: SRLED25 | 600MM (L) X 21MM (W) X 12MM (D)

- 12V milky ultra bright internal LED bar light



SWIVEL RAIL LIGHT

CODE: SRLED19 | 156MM (L) X 27.5MM (W) X 24.5MM (D)
CODE: SRLED20 | 298MM (L) X 27.5MM (W) X 24.5MM (D)
CODE: SRLED21 | 460MM (L) X 27.5MM (W) X 24.5MM (D)

- 12V LED internal swivel rail light
- White polycarbonate shell



DUAL COLOUR READING LIGHT WITH USB PORT

CODE: SRLED28 | SILVER
CODE: SRLED29 | BLACK

- 10-15V flexible reading light with dual colour light (cool white / blue)
- USB charger for devices
- Includes installation screws and guide

Dimensions:
60mm (dia. base) x 165mm (h)

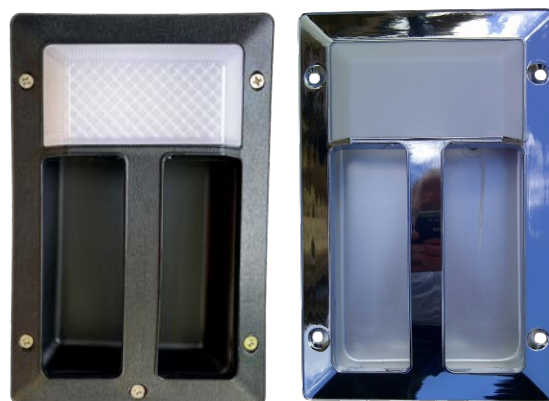

BARGMAN STYLE LAMP

CODE: SRLED6 | CHROME BASE
CODE: SRLED6B | BLACK BASE

- Polycarbonate ABS plastic housing
- 35 x LED lights



AWNING LIGHT

CODE: SRLED8W | WHITE
CODE: SRLED8B | BLACK

- Available in black and white

Dimensions:
250mm (l) x 40.5mm (w) x 30mm (h)



AWNING LIGHT

CODE: SRLED9W | WHITE
CODE: SRLED9B | BLACK

- Available in black and white

Dimensions:
550mm (l) x 40.5mm (w) x 30mm (h)



CODE: RL360DLEDB

- Single, STOP/TAIL
- 10 - 30V
- Black base

Dimensions:
400mm (l) x 46mm (d) x 15mm (h)



CODE: RL360DLEDC

- Single, INDICATOR
- 10V - 30V
- Chrome base

Dimensions:
400mm (l) x 46mm (d) x 15mm (h)



CODE: RL360SLEDB

- Single, INDICATOR
- 10V - 30V
- Black base

Dimensions:
400mm (l) x 46mm (d) x 15mm (h)



CODE: RL360SLEDC

- Single, STOP/TAIL
- 10 - 30V
- Chrome base

Dimensions:
400mm (l) x 46mm (d) x 15mm (h)



CODE: RL360RLEDB

- Single, REVERSE
- 10 - 30V
- Black base

Dimensions:
400mm (l) x 46mm (d) x 15mm (h)



CODE: RL360RLEDC

- Single, REVERSE
- 10 - 30V
- Chrome base

Dimensions:
400mm (l) x 46mm (d) x 15mm (h)



CODE: RL360SDLEDB

- Single, STOP/TAIL/INDICATOR
- 10 - 30V
- Black base

Dimensions:
400mm (l) x 46mm (d) x 15mm (h)



CODE: RL360SDLEDC

- Single, STOP/TAIL/INDICATOR
- 10 - 30V
- Chrome base

Dimensions:
400mm (l) x 46mm (d) x 15mm (h)



CODE: CRL360LEDB

- Combination, STOP/TAIL/INDICATOR
- 10 - 30V
- Black base

Dimensions:
400mm (l) x 82mm (d) x 15mm (h)



CODE: CRL360LEDC

- Combination, STOP/TAIL/INDICATOR
- 10 - 30V
- Chrome base

Dimensions:
400mm (l) x 82mm (d) x 15mm (h)



CODE: CRL360RLEDB

- Combination, STOP/TAIL/IND./REV.
- 10 - 30V
- Black base

Dimensions:
400mm (l) x 82mm (d) x 15mm (h)



CODE: CRL360RLEDC

- Combination, STOP/TAIL/IND./REV.
- 10 - 30V
- Chrome base

Dimensions:
400mm (l) x 82mm (d) x 15mm (h)



CODE: RL260DLEDB

- Single, INDICATOR
- 10 - 30V
- Black base

Dimensions:
259mm (l) x 46mm (d) x 15 mm (h)



CODE: RL260SLEDB

- Single, STOP/TAIL
- 10 - 30V
- Black base

Dimensions:
259mm (l) x 46mm (d) x 15 mm (h)



CODE: RL260RLEDB

- Single, REVERSE
- 10 - 30V
- Black base

Dimensions:
259mm (l) x 46mm (d) x 15 mm (h)



CODE: RL260SDLEDB

- Single, STOP/TAIL/INDICATOR
- 10 - 30V
- Black base

Dimensions:
259mm (l) x 46mm (d) x 15 mm (h)



CODE: CRL260RLEDB

- Combination, STOP/TAIL/INDICATOR / REVERSE
- 10 - 30V
- Black base

Dimensions:
259mm (l) x 82mm (d) x 15 mm (h)



CODE: CRL260LEDB

- Combination, STOP/TAIL/INDICATOR
- 10 - 30V
- Black base

Dimensions:
259mm (l) x 82mm (d) x 15 mm (h)

COMBINATION REAR LAMPS

ELECTRICAL & 12V



CODE: CRL350LEDB

- STOP/TAIL/INDICATOR
- Black base

Dimensions:
445mm (l) x 155mm (d) x 40 mm (h)



CODE: CRL350LEDC

- STOP/TAIL/INDICATOR
- Chrome base

Dimensions:
445mm (l) x 155mm (d) x 40 mm (h)



CODE: CRL350CLEDB

- STOP/TAIL/INDICATOR
- Clear lens, black base

Dimensions:
445mm (l) x 155mm (d) x 40 mm (h)



CODE: CRL350CLEDC

- STOP/TAIL/INDICATOR
- Clear lens, chrome base

Dimensions:
445mm (l) x 155mm (d) x 40 mm (h)



CODE: CRL350RLEDB

- Combination, STOP/TAIL/INDICATOR/REVERSE
- Black base

Dimensions:
445mm (l) x 155mm (d) x 40 mm (h)



CODE: CRL350RLEDC

- Combination, STOP/TAIL/INDICATOR/REVERSE
- Chrome base

Dimensions:
445mm (l) x 155mm (d) x 40 mm (h)



CODE: CRL350RCLEDB

- STOP/TAIL/INDICATOR/REVERSE
- Clear lens, black base

Dimensions:
445mm (l) x 155mm (d) x 40 mm (h)



CODE: CRL350RCLEDC

- STOP/TAIL/INDICATOR/REVERSE
- Clear lens, chrome base

Dimensions:
445mm (l) x 155mm (d) x 40 mm (h)



SM8 FRONT MARKER LAMP

CODE: FM8CLED

- Clear LED front clearance lamp with reflectors

Dimensions:
90mm (l) x 50mm (d) x 22mm (h)



SM8 REAR MARKER LAMP

CODE: RM8RLED

- Red LED rear marker lamp with reflectors

Dimensions:
90mm (l) x 50mm (d) x 22mm (h)



SM8 SIDE MARKER LAMP

CODE: SM8ALED

- Amber LED side marker lamp with reflectors

Dimensions:
90mm (l) x 50mm (d) x 22mm (h)



SM13 AMBER MARKER LAMP

CODE: SM13ALED

- Amber 'retrofit' LED marker
- Includes 0.5m cable

Dimensions:
120mm (l) x 64mm (d) x 32mm (h)



SM13 RED/AMBER MARKER LAMP

CODE: SM13RALED

- Red/amber 'retrofit' LED side marker
- Includes 0.5m cable

Dimensions:
120mm (l) x 64mm (d) x 32mm (h)



SM62 FRONT MARKER LAMP

CODE: FM62CLED

- Clear LED front clearance marker
- 9 - 33V
- Includes 0.5m cable

Dimensions:
57mm (l) x 35mm (d) x 21mm (h)



SM62 RED/AMBER SIDE MARKER LAMP

CODE: SM62RALED

- Red/amber side marker
- 9 - 33V
- Includes 0.5m cable

Dimensions:
57mm (l) x 35mm (d) x 21mm (h)



RM62 RED REAR MARKER LAMP

CODE: RM62RLED

- Red rear marker
- 9 - 33V
- Includes 0.5m cable

Dimensions:
57mm (l) x 35mm (d) x 21mm (h)



SM62 AMBER SIDE MARKER LAMP

CODE: SM62ALED

- Amber side marker
- 9 - 33V
- Includes 0.5m cable

Dimensions:
57mm (l) x 35mm (d) x 21mm (h)

RV & TRAILER HARDWARE





ECONOMY JOCKEY WHEEL

CODE: JW1E

- Solid rubber wheel with nylon web bore
- Includes clamp
- Unit Weight: 5.2kg
- Static Load Capacity: 500kg

Dimensions:
Wheel - 150mm x 50mm (6" x 2")
Lift - 225mm



EXTRA HEIGHT JOCKEY WHEEL

CODE: JW1EH

- Solid rubber wheel with nylon web bore
- Includes clamp
- Unit Weight: 6.2kg
- Static Load Capacity: 500kg

Dimensions:
Wheel - 150mm x 50mm (6" x 2")
Lift - 225mm



ECONOMY SWIVEL JOCKEY WHEEL

CODE: JW2E

- Solid rubber wheel with nylon web bore
- With pin locking swivel bracket welded in position
- Unit Weight: 6.0kg
- Static Load Capacity: 350kg

Dimensions:
Wheel - 150mm x 50mm (6" x 2")
Lift - 225mm



ECONOMY SWIVEL JOCKEY WHEEL

CODE: JW2UBE

- Solid rubber wheel with nylon web bore
- With pin locking swivel bracket welded in position
- For fixing with U-Bolts (suits 2", 3", 4", 5" & 6" U-Bolts)
- Unit Weight: 6.2kg
- Static Load Capacity: 350kg

Dimensions:
Wheel - 150mm x 50mm (6" x 2")
Lift - 225mm



MEDIUM JOCKEY WHEEL

CODE: JW4Z

- Rubber tyre with zinc plated steel centre and roller bearings
- Includes clamp
- Unit Weight: 6.6kg
- Static Load Capacity: 750kg

Dimensions:
Wheel - 200mm x 55mm (8" x 2")
Lift - 225mm



EXTRA HEIGHT JOCKEY WHEEL

CODE: JW4ZEH

- Rubber tyre with zinc plated steel centre and roller bearings
- Includes clamp
- Unit Weight: 8.5kg
- Static Load Capacity: 700kg

Dimensions:
Wheel - 200mm x 55mm (8" x 2")
Lift - 225mm

MEDIUM SWIVEL JOCKEY WHEEL

CODE: JW4ZUB

- Rubber tyre with zinc plated steel centre and roller bearings
- With pin locking swivel bracket welded in position
- For fixing with U-Bolts (suits 2", 3", 4", 5" & 6" U-Bolts)
- Unit Weight: 9.6kg
- Static Load Capacity: 750kg

Dimensions:

Wheel - 200mm x 55mm (8" x 2")

Lift - 225mm



EXTRA HEIGHT JOCKEY WHEEL

CODE: JW9EHD

- Solid cushion tyre with steel centre and bronze bush bore
- 'Pneumatic Look' solid rubber
- Increased capacity; includes H/D clamp
- Unit Weight: 12.2kg
- Static Load Capacity: 850kg

Dimensions:

Wheel - 4.10 / 3.50 x 4 (10")

Lift - 225mm



STANDARD SWIVEL JOCKEY WHEEL

CODE: JWSW-2

- Solid rubber with nylon web bore
- Side winding with pin locking swivel bracket welded in position
- Unit Weight: 7.5kg
- Static Load Capacity: 500kg

Dimensions:

Wheel - 150mm x 50mm (6" x 2")

Lift - 225mm

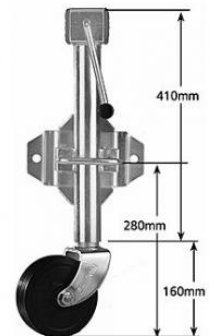

SWIVEL JOCKEY WHEEL

CODE: JW10S

- Solid cushion tyre with steel centre and bronze bush bore
- 'Pneumatic Look' solid rubber
- With pin locking swivel bracket welded in position
- Unit Weight: 11.1kg
- Static Load Capacity: 850kg

Dimensions:

Wheel - 4.10 / 3.50 x 4 (10")

Lift - 225mm



EXTRA HEIGHT JOCKEY WHEEL

CODE: JWSW-4ZEH

- Rubber tyre with zinc plated steel centre and roller bearings
- Side winding; includes clamp
- Unit Weight: 8.6kg
- Static Load Capacity: 700kg

Dimensions:

Wheel - 200mm x 55mm (8" x 2")

Lift - 225mm

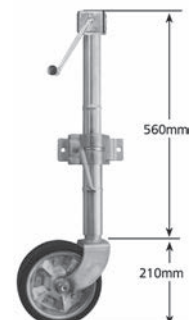



SMALL ADJUSTABLE LEG

CODE: ALQR1 | ZINC PLATED FINISH
CODE: ALQR1-HT | H/TONE FINISH

- Weld on
- Unit Weight: 4.7kg
- Height: 400mm / Lift: 120mm



MEDIUM ADJUSTABLE LEG

CODE: ALQR2 | ZINC PLATED FINISH
CODE: ALQR2-HT | H/TONE FINISH

- Weld on
- Unit Weight: 5.1kg
- Height: 460mm / Lift: 180mm



LARGE ADJUSTABLE LEG

CODE: ALQR3 | ZINC PLATED FINISH
CODE: ALQR3-HT | H/TONE FINISH

- Weld on
- Unit Weight: 5.7kg
- Height: 520mm / Lift: 140mm

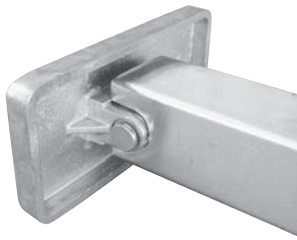

SMALL ADJUSTABLE LEG WITH ALUMINIUM FOOT

CODE: ALQR1-AF

- Unit Weight: 4.7kg
- Height: 400mm
- Lift: 120mm

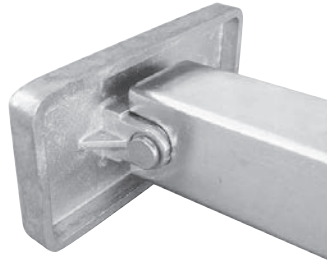

MEDIUM ADJUSTABLE LEG WITH ALUMINIUM FOOT

CODE: ALQR2-AF

- Unit Weight: 5.1kg
- Height: 460mm
- Lift: 180mm

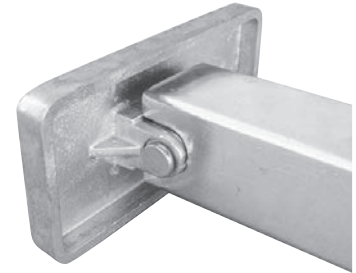

LARGE ADJUSTABLE LEG WITH ALUMINIUM FOOT

CODE: ALQR3-AF

- Unit Weight: 5.7kg
- Height: 520mm
- Lift: 140mm



EXTRA LARGE ADJUSTABLE LEG, STEEL FOOT

CODE: ALQR4LP | ZINC PLATED FINISH
CODE: ALQR4LP-HT | HAMMERTONE FINISH

- Weld on
- Unit Weight: 6.2kg
- Height: 620mm
- Lift: 180mm

NEW!



QUICK RELEASE ADJUSTABLE LEG WITH ALUMINIUM FOOT

CODE: AL-ALQR1-3

- Replaces ALQR1, ALQR2 & ALQR3
- Unit Weight: 8.00kg
- Closed Height: 430mm
- Extension Leg Max: 160mm
- Lift Leg Max: 120mm
- Extended Height: 710mm

NEW!

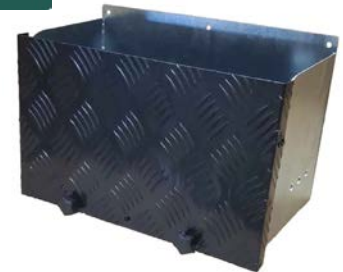

BATTERY BOX

CODE: BATBOXSET

- Suits batteries up to 380mm wide
- Pack includes 1 base, 1 lid, 1 angle pcs, 2 hooks, 2 knobs
- Dimensions: 380mm (l) x 200mm (w) x 215mm (h)



ALUMINIUM FOOT

CODE: ALQRAF

- Suits ALQR leg



PLASTIC FOOT

CODE: ALQRPF

- Suits ALQR leg

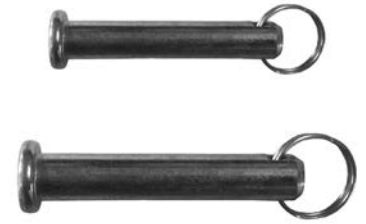

PIN FOR REPLACEMENT FOOT

CODE: ALQRPS | SMALL
CODE: ALQRPL | LARGE

- Small, to suit plastic covered feet
- Large, to suit aluminium feet



LARGE JOCKEY WHEEL HOLDER

CODE: SRWJCH

- Can be pegged to the ground
- Made from black plastic

Dimensions:
204mm (dia.) x 35mm (h)



RUBBER WHEEL HOLDER

CODE: RWH

- Support cradle for use under 200mm and 250mm jockey wheels
- Unit Weight: 0.55kg

Dimensions:
170mm (l) x 130mm (w) x 40mm (h)



LARGE RUBBER WHEEL HOLDER

CODE: RWHL

- Large support cradle for use under 200mm and 250mm jockey wheels

Dimensions:
200mm (l) x 130mm (w) x 50mm (h)



P SERIES HANDLE

CODE: LH2P | SLOTTED TYPE | 700MM (L) | WEIGHT: 680G

CODE: LH2PD | SLOTTED TYPE, DRILL STYLE | 570MM (L) | WEIGHT: 500G



HEX HEAD HANDLE

CODE: LH2M | HEX HEAD TYPE | 700MM (L) | WEIGHT: 840G

CODE: LH2MD | HEX HEAD TYPE, DRILL STYLE | 590MM (L) | WEIGHT: 600G



CARAVAN JACK PAD

CODE: SRWJ

- Four piece set

Dimensions:
180mm (d) x 140mm (w) x 50mm (h)



JACK PAD STACKER

CODE: SRWJP

- Four piece set

Dimensions:
145mm (d) x 145mm (w) x 40mm (h)

D-SHACKLES

CODE: DS1 | SMALL
 CODE: DS2 | MEDIUM
 CODE: DS3 | LARGE

DS1 | 1000kg WLL rated; ADR Approved; 10mm

DS2 | 1500kg WLL rated; ADR Approved; 11mm

DS3 | 2000kg WLL rated; ADR Approved; 13mm



BOW SHACKLES

CODE: BSH1 | SMALL
 CODE: BSH2 | MEDIUM
 CODE: BSH3 | LARGE

BSH1 | 1000kg WLL rated; ADR Approved; 10mm

BSH2 | 1500kg WLL rated; ADR Approved; 11mm

BSH3 | 2000kg WLL rated; ADR Approved; 13mm



A TYPE BEARING SET

CODE: MLMAJ

- Japanese; similar to Holden
- Includes small and large bearing and A-type seal



B TYPE BEARING SET

CODE: MLMBJ

- Japanese slimline or heavy duty bearings, similar to Ford car bearings
- Includes small and large bearing and B-type seal



TWIN COUPLING LOCK

CODE: TCL

- Twin coupling lock complete with 38mm brass padlock
- Unit weight: 1.86kg

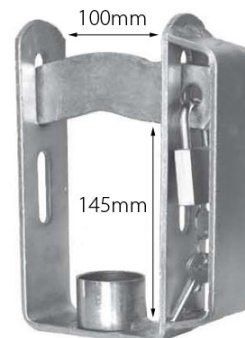



JERRY CAN HOLDER

CODE: JCHD

- Zinc plated finish
- Weld on style / metal strap
- Unit Weight: 3.0kg

Inside Dimensions:
180mm (d) x 370mm (w) x 295mm (h)

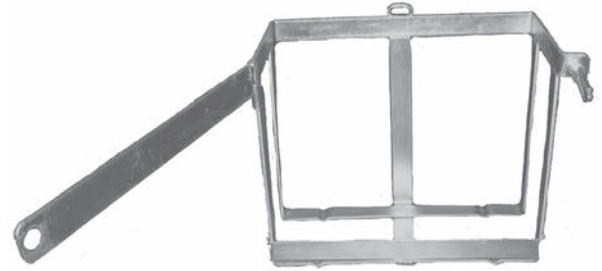

JERRY CAN HOLDER, FRONT OPENING

CODE: JCHDO

- Zinc plated finish
- Weld on style / metal strap
- Unit Weight: 3.4kg

Inside Dimensions:
180mm (d) x 370mm (w) x 295mm (h)



JERRY CAN HOLDER, HAMMERTONE FINISH WITH SIDE FLANGES

CODE: JCHD-SF

- Hammertone finish
- Bolt on style / with side flanges
- Unit Weight: 6.0kg

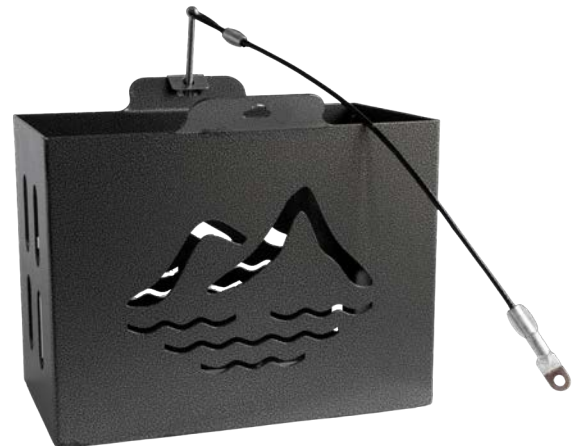

JERRY CAN HOLDER, HAMMERTONE FINISH WITHOUT SIDE FLANGES

CODE: JCHD-NSF

- Hammertone finish
- Bolt on style / no side flanges
- Unit Weight: 6.0kg

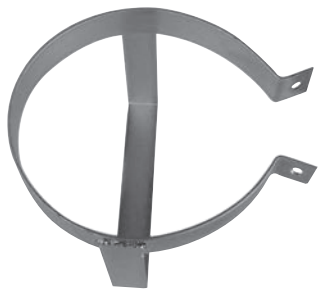

SMALL GAS BOTTLE HOLDER

CODE: GBHDS

- To suit 4.0kg - 4.5kg gas bottle
- Zinc plated finish, weld on style
- Unit Weight: 1.4kg



LARGE GAS BOTTLE HOLDER

CODE: GBHDL

- To suit 9.0kg gas bottle
- Zinc plated finish, weld on style
- Unit Weight: 1.6kg



SMALL ADJUSTABLE GAS BOTTLE HOLDER, FRONT OPENING

CODE: AGBHSO

- Suits 4.0kg gas bottle
- Weld on style
- Unit Weight: 1.86kg



LARGE ADJUSTABLE GAS BOTTLE HOLDER, FRONT OPENING

CODE: AGBHLO

- Suits 9.0kg gas bottle
- Weld on style
- Unit Weight: 2.0kg

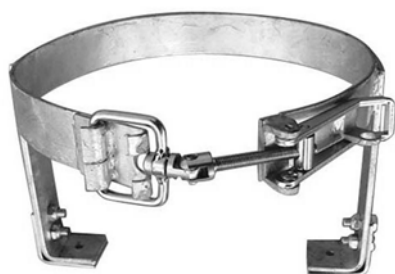

SMALL ADJUSTABLE GAS BOTTLE HOLDER

CODE: AGBHS

- Zinc plated, to suit 4.0kg gas bottle
- Mount brackets for weld on
- Galvanised holder bolted to brackets for easy replacement
- Fully adjustable and lockable
- Unit Weight: 1.86kg

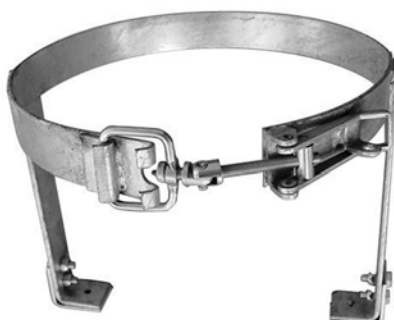

LARGE ADJUSTABLE GAS BOTTLE HOLDER

CODE: AGBHL

- Zinc plated, to suit 9.0kg gas bottle
- Mount brackets for weld on
- Galvanised holder bolted to brackets for easy replacement
- Fully adjustable and lockable
- Unit Weight: 2.36kg



RUBBER RING

CODE: AGBHS-RR | SMALL
CODE: AGBHL-RR | LARGE

- Place around metal ring of holder to prevent chafing and wear & tear
- 100% rubber ring, black

Note: Gas Bottle Holder not included

BEDDING



TREKWAY SELF INFLATING MAT, 10CM

CODE: AB508 | SINGLE | 195CM (L) X 70CM (W) X 10CM (D)
 CODE: AB509 | DOUBLE | 195CM (L) X 140CM (W) X 10CM (D)

- Extra comfort self inflating mattress (10cm thickness)
- Made from high quality thermoplastic polyurethane
- Includes carry bag
- Top & side walls: 30D stretch-knitted fabric-coated TPU
- Base: 210D oxford with TPU coating
- R value: 8.5



TREKWAY CROSS LEG STRETCHER

CODE: 33L

- 150kg weight rating
- 400D PVC
- product weight: 7.1kg

Dimensions:
 2170mm (l) x 770mm (w) x 520mm (h)



HIKER SELF-INFLATING MAT

CODE: AB507

- Single person self inflating mattress, perfect for hikers
- Includes carry bag
- R Value: 3.2
- Weight: 880g

Dimensions:
 185cm (l) x 53cm (w) x 35cm (d)



VELOUR AIR BEDS

CODE: AIRB1 | SINGLE | 185CM (L) X 76CM (W) X 22CM (D)
 CODE: AIRB2 | TWIN | 188CM (L) X 99CM (W) X 22CM (D)
 CODE: AIRB3 | DOUBLE | 191CM (L) X 137CM (W) X 22CM (D)
 CODE: AIRB4 | QUEEN | 203CM (L) X 152CM (W) X 22CM (D)

- SID Valve (Smart Inflation/Deflation)
- Coil beam construction
- PVC base
- Velour top

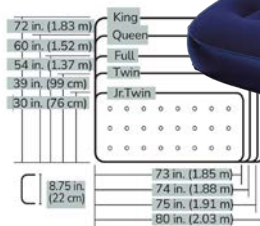

BOSTON VALVE

CODE: BV

- Replacement Boston Valve to suit Velour Air Beds



FURNITURE



ALUMINIUM DIRECTORS CHAIR

CODE: 23JA

- Lightweight directors chair with side table, cup holder and phone holder.
- Folds flat for easy storage and transportation.
- Made from 600D polyester fabric with PVC coating
- Weight Rating: 120kg
- Product weight: 3.8kg

Dimensions:

Total Height: 970 mm

Seat: 510mm (h) x 430mm (d) x 530mm (w)

Stored: 540mm (d) x 170mm (w) x 970mm (h)



NEW!

RECLINING HARD ARM CHAIR

CODE: 23S

- Reclining Chair with hard arm rests, phone pocket and cup holder
- Completely collapsible into carry bag with strap
- Expandable cup holder
- Phone holder pocket
- Made from 600D polyester fabric with PVC coating
- Weight Rating: 120kg
- Product weight: 6.5kg

Dimensions:

Total Height: 970 mm

Seat: 510mm (h) x 430mm (d) x 530mm (w)

Stored: 540mm (d) x 170mm (w) x 970mm (h)



NEW!



CAMP QUAD CHAIR

CODE: 23L

- Made from durable 600D PVC fabric with 19mm powder coated steel frame
 - Features mesh cup holder, includes carry bag
- Weight Rating: 100kg / Product Weight: 2.2kg

Dimensions: Back: 91cm / Seat: 44cm (h) x 50cm (d) x 45cm (w)
 Stored Dimensions: 20cm (d) x 20cm (w) x 108cm (h)



KING SIZE ACTION CHAIR

CODE: 23K

- Made from durable 600D PVC fabric with 19mm powder coated steel frame, includes carry bag
 - Features fabric cup holder, side pocket and quilted design
- Weight Rating: 130kg / Product Weight: 3.5kg

Dimensions: Back: 111cm / Seat: 50cm (h) x 53cm (d) x 59cm (w)
 Stored Dimensions: 23cm (d) x 23cm (w) x 104cm (h)



STEEL DIRECTORS CHAIR

CODE: 23JS

- Black powder coated steel frame
 - Made from 600D PVC fabric
 - Features: front and back anti-tip leg design, foldable side table, cup holder, single piece cover
- Weight rating: 120kg
 Product Weight: 6.3kg

Dimensions: Back: 85cm / Seat: 43cm (h) x 42cm (d) x 47cm (w)
 Stored Dimensions: 20cm (d) x 30cm (w) x 85cm (h)



TRI-LEG STOOL

CODE: 21E | 50CM (H)
 CODE: 21F | 65CM (H)

- 19mm steel legs with 600D PVC fabric cover
- Weight rating: 100kg / Product Weight: 0.9kg

21E Dimensions: Seat: 30cm (d) x 30cm (w) / Stool height: 50cm
 Stored Dimensions: 7cm (d) x 8cm (w) x 58cm (h)

21F Dimensions: Seat: 33cm (d) x 33cm (w) / Stool height: 65cm
 Stored Dimensions: 7cm (d) x 8cm (w) x 77cm (h)

A close-up photograph of a person sitting in a green folding chair. The person is wearing a plaid shirt and is leaning forward. The chair's backrest is dark green with a white stripe on the left side. The word "supex" is printed in white on the backrest. The background is a blurred, warm-toned wall.

supex

FIND YOUR PATH

SMALL HOOP LEG STOOL

CODE: 21B

- Galvanised 19mm steel frame
- Canvas cover {colours vary}

Dimensions:

- Stool height - 41cm
- Seat area - 22cm (d) x 31cm (w)

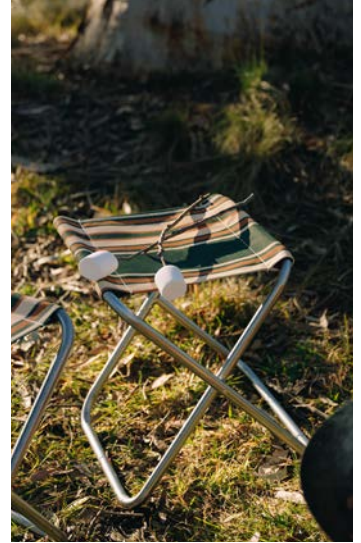

LARGE HOOP LEG STOOL

CODE: 21C

- Galvanised 19mm steel frame
- Canvas cover {colours vary}

Dimensions:

- Stool height - 45cm
- Seat area - 28cm (d) x 34cm (w)



CHAIRETTE

CODE: 23D

- Galvanised 19mm steel frame
- Canvas cover {colours vary}

Dimensions:

- Stool height - 40cm
- Seat area - 32cm (d) x 33cm (w)





UTILITY TABLE

CODE: 31K

- Portable & lightweight
- Easy to carry, quick to set up
- Aluminium frame with MDF top
- Folds flat to save space

Dimensions:
38cm (d) x 53cm (w) x 64cm (h)
Product Weight: 2.5kg



PERSONAL TABLE

CODE: 31M

- Blow-moulded for superior strength
- Folds flat for the space efficiency
- Four adjustable height positions
- Steel legs, 19mm dia.

Dimensions:
50cm (d) x 77cm (w)
Heights: 12cm, 50cm, 63.5cm, 74cm
Product Weight: 5.0kg



SMALL FOLD IN HALF TABLE

CODE: 31S

- Lightweight fold in half table
- Black aluminium frame with woodgrain style MDF top
- Small & compact for efficient use of space

Dimensions:
39.5cm (d) x 60cm (w) x 40cm (h)
Product Weight: 2.0kg



LIGHTWEIGHT TABLE

CODE: 31G

- Classic camping table, easy to carry and assemble
- Folding legs for compact storage
- Aluminium frame with MDF top

Dimensions:
60cm (d) x 80cm (w) x 70cm (h)
Product Weight: 3.6kg

WANDERLITE ULTRA HIKER CHAIR

CODE: 23G

- Ultralight collapsible chair made from 600D Oxford cloth with high strength aluminium alloy frame
- Features: easy assembly, foldable legs, scientifically structured design
- Weight Rating: 150kg / Product Weight: 0.92kg

Dimensions: 51cm (d) x 57cm (w) x 65cm (h)
- Fits into carry bag - 11cm (d) x 15cm (w) x 36cm (l)



WANDERLITE MIGHTY HIKER CHAIR

CODE: 23F

- Medium lightweight collapsible chair made from 600D Oxford cloth with high strength aluminium alloy frame
- Features: mesh pocket, bottle holder, easy assembly, foldable legs, scientifically structured design
- Weight Rating: 120kg / Product Weight: 1.39kg

Dimensions: 64cm (d) x 65cm (w) x 79 cm (h)
- Fits into carry bag - 11cm (d) x 47cm (l)



WANDERLITE VOYAGER CHAIR

CODE: 23M

- Large lightweight collapsible chair made from 600D Oxford cloth with high strength aluminium alloy frame
- Features: easy assembly, foldable legs, scientifically structured design, padded headrest
- Weight Rating: 120kg / Product Weight: 1.45kg

Dimensions: 80cm (d) x 53cm (w) x 97cm (h)
- Fits into carry bag - 10cm (d) x 47cm (l)

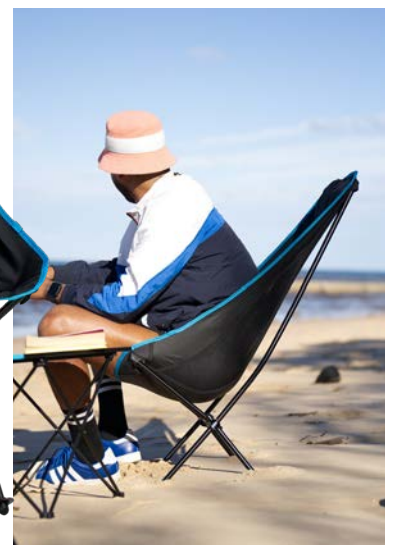

WANDERLITE NOMAD TABLE

CODE: 23W

- Super-light slat table, includes carry bag
- High strength aluminium alloy frame with black plastic clip-on slats
- Features: easy assembly, flat-pack legs and slats, scientifically structured design
- Weight Capacity: 15kg / Product Weight: 1.2kg

Dimensions: 40cm (d) x 56cm (w) x 40cm (h)

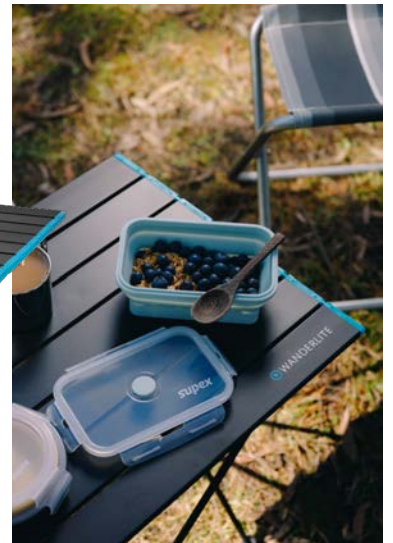

WANDERLITE SEEKER TABLE

CODE: 23X

- Reinforced fabric top table
- 300D rip-stop polyester with high strength aluminium alloy frame
- Features: two large cup holders, anti-sink foot stops
- Weight capacity: 15kg

Dimensions: 38cm (d) x 59cm (w) x 40cm (h)



NEW!



COOKWARE





DUTCH OVEN LID LIFTER

CODE: DOL1

Dimensions: 425mm (l)

DO100



DO120



DO25



DO45



DO90



PRE-SEASONED DUTCH OVENS

CODE: DO25 | 2.5 QUART
 CODE: DO45 | 4.5 QUART
 CODE: DO90 | 9 QUART
 CODE: DO100 | 10 QUART
 CODE: DO120 | 12 QUART

- Lipped lid with lifting hook and carry handle
- Made with traditional cast-iron for even heat distribution when cooking



LARGE TRIPOD

CODE: TP3 | 10MM (DIA.) X 900MM (H)
 CODE: TP4 | 10MM (DIA.) X 1200MM (H)

- Solid steel
- Includes carry bag



SMALL COLLAPSIBLE TRIPOD

CODE: TP5

- Multipurpose; can be used with frypans, skillets, ovens, woks and saucepans
- Folds flat for easy storage
- Includes carry bag



RECTANGULAR GRIDDLE PAN

CODE: FPFH1

- Pre-seasoned with a wooden handle and griddle base

Dimensions:
210mm (w) x 350mm (d)



ROUND GRIDDLE PAN

CODE: FPFH2

- Pre-seasoned with a wooden handle and griddle base

Dimensions:
240mm dia.



SQUARE GRIDDLE PAN

CODE: FPFH3

- Pre-seasoned with a wooden handle and griddle base

Dimensions:
240mm (w) x 240mm (d)



ROUND FRYPANS

CODE: FP9 | ROUND | 220MM DIA.
CODE: FP11 | ROUND | 280MM DIA.
CODE: FP12 | ROUND | 300MM DIA.

- Pre-seasoned with wooden screw-in handle



SQUARE FRYPANS

CODE: FP10

- Pre-seasoned with wooden screw-in handle
- Square, griddle base

Dimensions:
250mm (w) x 250mm (d)





SMALL SAUCEPAN

CODE: SP2

- Pre-seasoned with wooden handle

Volume:
- Two quart



MEDIUM SAUCEPAN

CODE: SP3

- Pre-seasoned with wooden handle

Volume:
- Three quart



SINGLE JAFFLE IRON

CODE: JISL

- Pre-seasoned with metal clasp and wooden handle

Dimensions:
130mm (w) x 140mm (d)



DOUBLE JAFFLE IRON

CODE: JIDL

- Pre-seasoned with metal clasp and wooden handle

Dimensions:
275mm (w) x 140mm (d)



SINGLE SLICE TOASTER

CODE: MBSTT

- Single slice box toaster

Dimensions:
110mm (d) x 165mm (w) x 30mm (h)



FOUR SLICE TOASTER

CODE: M4SLT

- Four slice box toaster

Dimensions:
200mm (dia.) x 15mm (h) | Assembled height
- 220mm

MUG

CODE: SUP110007 | 7CM DIA. | 250ML
CODE: SUP110008 | 8CM DIA. | 400ML
CODE: SUP110009 | 9CM DIA. | 500ML
CODE: SUP110010 | 10CM DIA. | 750ML



MUG WITH LID

CODE: SUP110108 | 8CM DIA. | 400ML
CODE: SUP110109 | 9CM DIA. | 500ML
CODE: SUP110110 | 10CM DIA. | 750ML



PLATE

CODE: SUP120020 | 20CM DIA.
CODE: SUP120023 | 23CM DIA.



BOWL

CODE: SUP111014 | 14CM DIA. | 800ML
CODE: SUP111018 | 18CM DIA. | 1.6L

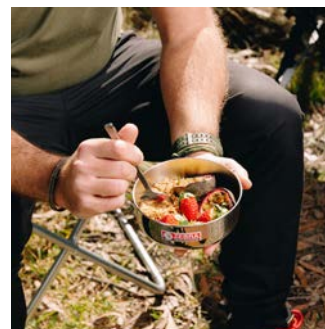

ROUND LUNCH BOX

CODE: SUP152312 | 12CM D. | 700ML
CODE: SUP152314 | 14CM D. | 1.1L



BILLY WITH LID

CODE: SUP113114

- Billy style tea pot with seamless interior, fitted lid, folding handle and slotted spout
- 14cm diameter | 2.0L capacity



WHISTLING KETTLE

CODE: SUP113524 | 3.5L CAPACITY



CAMPING SET

CODE: SUP184211

- Three piece camping set with carry bag
- Includes two pots (one with folding handle) and frying pan with folding handle

Dimensions:

Pot with handle - 14cm dia., 1.2L capacity

Pot with folding handle - 16cm dia., 1.7L capacity

Frying pan with folding handle - 16cm dia., 700ml capacity



STOCK POT

CODE: SUP171228

- For use on all stoves
- 28cm diameter
- 17.2L capacity





LUNCH BOX

CODE: SUP152016

- Rectangular lunch box
- Includes round inner box

Dimensions:
16cm (l) x 12.5cm (w) x 5.8cm (h)
780ml capacity



LOOP HANDLE POT

CODE: SUP151612 | 12CM DIA. | 1.4L
CODE: SUP151614 | 14CM DIA. | 2.0L
CODE: SUP151616 | 16CM DIA. | 3.0L



TIERED LUNCH BOX

CODE: SUP152042

- Two tier oval lunch box
- Includes inner box
- Sturdy lock, foldable handle

Dimensions:
14cm diameter | 1.1L capacity



TIERED FOOD CARRIER

CODE: SUP150103 | 10CM DIA. | THREE TIER FOOD CARRIER
CODE: SUP150122 | 12CM DIA. | TWO TIER FOOD CARRIER
CODE: SUP150142 | 14CM DIA. | TWO TIER FOOD CARRIER

BEACH & SHELTER





SINGLE SEAT BOAT SET

CODE: BT1

- Single seat inflatable boat; inflatable floor for comfort
- Features: tow ring & tow rope, built-in grommets
- Weight Rating: 80kg

Dimensions: 107cm (w) x 165cm (l)



DOUBLE SEAT BOAT SET

CODE: BT2

- Double seat inflatable boat; inflatable floor for comfort
 - Features: tow ring & tow rope, built-in grommets, oar clasps
 - Includes oar set & foot pump
- Dimensions: 115cm (w) x 197cm (l)



PLASTIC OAR SET

CODE: OAR1

- Plastic oar set with ribbed blade
- Three section structure for easy assembly



ALUMINIUM OAR SET

CODE: OAR2

- Sectional aluminium oar set
- Can be used as one twin blade paddle; 2.18m (l) OR two single blade paddles, each 1.45m (l)



12V AIR PUMP

CODE: PP1

- DC 12V, 96W
- Large air chamber for inflation
- Plugs into 12V car outlet
- Max airflow: 680 L/min



240V AIR PUMP

CODE: PP2

- 240V, 110W
- Large air chamber for inflation
- Three valve adaptors
- Max airflow: 680 L/min



FOOT BELLOWS

CODE: PP3

- Foot bellows, 5000CC



PUSH / PULL PUMP

CODE: PP4

- 13000CC
- Inflates/deflates on up/down stroke

3M X 3M GAZEBO

CODE: GAZ33

- 2.9m x 2.9m gazebo with wheeled carry bag
- Includes ropes & pegs
- Waterproof, 420D Oxford PVC coated polyester canopy
- Weight: 22kg
- Adjustable height
- UPF Rating 50+

Dimensions:
2900mm (w) x 2900mm (d)
x 3120mm-3320mm (h (lowest to highest))

NEW!



3M X 3M GAZEBO SOLID WALL

CODE: GAZWAL

- 3m solid side wall, fits to any side of the 3m x 3m gazebo
- Attaches with hook & loop tape
- Waterproof, 420D Oxford PVC coated polyester canopy
- UPF Rating 50+

Dimensions:
3000mm (w) x 3000mm (h)

NEW!





BEACH TENT

CODE: SUP68105

- Simple set up
- Includes carry bag for easy transport
- Capacity: 2 people
- Fabric: 190T polyester PA coated
- Ground protection: 100g/m² PE



SECURA BEACH TENT

CODE: SUP68107

- Sets up in seconds
- Protection from sun with UPF40+ rating
- Capacity: 2 people
- Fabric: 190T polyester PA silver coated
- Ground protection: 120g/m² PE



RAMBLE X2 TENT

CODE: SUP68001

- Easy to set up and convenient to carry
- Capacity: 2 people
- Fabric: 170T polyester PA coated
- Ground protection: 110g/m² PE



CHANGING STATION

CODE: SUP68002

- Offers privacy by the beach, lake or pool
- Two side windows and removable floor drain
- Capacity: 1 person
- Fabric: 170T polyester PA Coated
- Ground protection: 110g/m² PE

CAMPSITE ACCESSORIES





FIXED SHOVEL

CODE: SHV1

- Fixed handle shovel
- Wooden handle, 750mm (l)



FOLDING SHOVEL

CODE: SHV2

- Tri-fold metal handle shovel
- Includes carry bag



MALLET

CODE: MAL

- Weight: 1.2kg
- Fibreglass handle, 230mm (l)



CAMPING HATCHET

CODE: HTC1

- Weight: 1.2kg
- Fibreglass handle, 230mm (l) - Stone hammer
- Weight: 1.2kg
- Fibreglass handle, 230mm (l)



MINI SPLITTER

CODE: MISP

- Weight: 1.75kg
- Fibreglass handle, 330mm (l)

NEW!



RUBBER NOSE CONES

CODE: AC31

- Replacement seal
- To suit Bromic POL regulator
- Pack of 3

NEW!



RUBBER O - RINGS

CODE: AC30

- To suit Bromic POL adaptors
- Pack of 3

Dimensions: 13mm dia. (inside) x 2mm



SOLAR SHOWER

CODE: SOL1

- Capacity: 20L



CANVAS SHOWER

CODE: 41BSC

- With plastic rose
- Capacity: 20L

RECHARGEABLE FAN

CODE: CF01

- 270° fan with LED, night & SOS lights
 - 3 fan settings, 3 light settings
 - Run time: 5 - 12 hours
- Product Weight: 890g

Dimensions:
215mm (w) x 245mm (h) x 80mm (d)



RECHARGEABLE AIR PUMP

CODE: AP01

- Compact, portable & rechargeable
 - With hanging hook and LED light
 - Powerful air flow: 200-250L/m
- Product Weight: 162g

Dimensions:
50mm (w) x 89mm (h) x 55mm (d)



RECHARGEABLE LIGHT

CODE: HL08

- Multipurpose light with 6 modes
 - Use closed, partly or fully opened
 - Can be used as a power bank
 - Includes hook and carry bag
- Product Weight: 420g / IPX5

Dimensions:
55mm (w) x 220mm (h) x 55mm (d)



VERSA LIGHT 25

CODE: VL25

- Rechargeable waterproof multi-use light
- Features five light modes: torch, daylight, bug repellent amber, cool white & flashing SOS
- All modes dimmable
- Heavy duty lanyard, glass breaker & built in magnets
- Waterproof to IP66
- Battery: 2500mAh, USB-C Charging (cord included)

Dimensions:
155mm (l) x 42mm (w)



NEW!

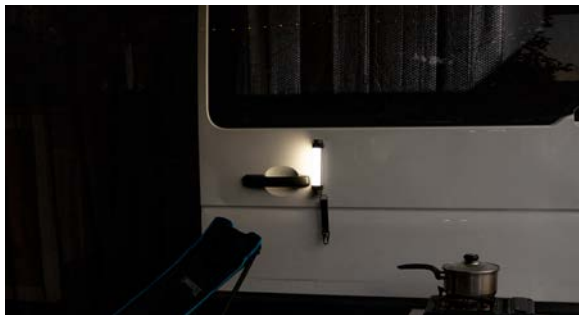

VERSA LIGHT 44

CODE: VL44

- Rechargeable waterproof multi-use light
- Features five light modes: torch, daylight, bug repellent amber, cool white & flashing SOS
- All modes dimmable
- Heavy duty lanyard, glass breaker & built in magnets
- Waterproof to IP66
- Battery: 4400mAh, USB-C Charging (cord included)

Dimensions:
210mm (l) x 42mm (w)



NEW!



VERSA LIGHT 66

CODE: VL66

- Rechargeable waterproof multi-use light
- Features five light modes: torch, daylight, bug repellent amber, cool white & flashing SOS
- All modes dimmable
- Heavy duty lanyard, glass breaker & built in magnets
- Waterproof to IP66
- Battery: 6600mAh, USB-C Charging (cord included)

Dimensions:
290mm (l) x 42mm (w)



NEW!



VIBE LIGHT

CODE: VIBE1

- Rechargeable string lights for camping with lamp & torch
- 9m of string lights with 8 different light modes to set the campsite vibe
- Waterproof to IP44
- Handle for hanging under awning, gazebo or tent
- Power: 3000 mAh
- Charging time: 5 hours (USB-C cord included)
- 8 different light modes:
 1. Warm white string lights
 2. Warm white and multi-colour flashing string lights
 3. Multi-colour breathing string lights
 4. Warm white string lights with lamp
 5. Bright warm lamp only
 6. Bright torch
 7. Dim torch
 8. Bright flashing (SOS) torch

Dimensions:
108mm dia. x 37mm (h)



NEW!



MADE IN AUSTRALIA



RECTANGULAR PLASTIC BASIN

CODE: PCS

Dimensions:

- 300mm (d) x 360mm(w) x 120mm (h)
- Volume: 9L

MADE IN AUSTRALIA



COLLAPSIBLE CONTAINER

CODE: CWC10 | VOLUME: 10L

CODE: CWC20 | VOLUME: 20L

MADE IN AUSTRALIA



SMALL WATER CUBE

CODE: PC15 | VOLUME: 15L

- Made from food grade HDPE
- BPA free

MADE IN AUSTRALIA



MEDIUM WATER CUBE

CODE: PC20 | VOLUME: 20L

- Made from food grade HDPE
- BPA free

MADE IN AUSTRALIA



LARGE WATER CUBE

CODE: PC25 | VOLUME: 25L

- Made from food grade HDPE
- BPA free

MADE IN AUSTRALIA



SMALL WATER JERRY CAN

CODE: AT5 | VOLUME: 5L

- Food grade HDPE, BPA free

MADE IN AUSTRALIA



MEDIUM WATER JERRY CAN

CODE: AT10 | VOLUME: 10L

- Food grade HDPE, BPA free

MADE IN AUSTRALIA



LARGE WATER JERRY CAN

CODE: AT20 | VOLUME: 20L

- Food grade HDPE, BPA free

MADE IN AUSTRALIA



HD WATER JERRY CAN

CODE: AT20G | VOLUME: 20L

- Food grade HDPE, BPA free
- Heavy duty



FUEL DRUMS

CODE: J5 | VOLUME: 5L | PETROL
 CODE: J10 | VOLUME: 10L | PETROL
 CODE: J20C | VOLUME: 20L | RED | PETROL
 CODE: J20F | VOLUME: 20L | YELLOW | DIESEL

- Fully approved fuel containers



UNIVERSAL ON/OFF TAP

CODE: PCT



AEROFLOW TAP

CODE: PCAFC

- To suit water cube

HANG SELL AVAILABLE



ON/OFF SNAP TAP

CODE: SNT



BUNG AEROFLOW TAP

CODE: PCAFB

- To suit water cube and/or jerry can



UNIVERSAL BUNG

CODE: PCB



DRUM SPANNER

CODE: SPA

- Assists opening water cube caps & bungs



CAP

CODE: PCC

- To suit water cube

MAINTENANCE & REPAIR





TEAR AID, RETAIL PACK

CODE: TAO | TYPE A GOLD
 CODE: TAB | TYPE B BLUE
 CODE: TAV | TYPE B GREEN
 CODE: TAY | TYPE B YELLOW

- Includes 1 x 75mm (w) x 300mm (l) piece
- Plus additional small patches



TEAR AID, WORKSHOP PACK

CODE: TAO2 | TYPE A GOLD
 CODE: TAV2 | TYPE B GREEN

- Includes 1 x 75mm (w) x 1500mm (l) roll



STIMEX WATERPROOFER

CODE: STWP | SPRAY CAN, 500ML
 CODE: STWB | LIQUID, 500ML

- High concentrate textile coating for fabric treatment
- Permanently elastic and breathable
- Can be applied to moist fabric
- Liquid dilutes to 4L | Spray covers 20m²



STIMEX OUTDOOR SPRAY

CODE: STOS | SPRAY CAN | VOLUME: 500ML

- For use on outer of outdoor clothing made from waterproof, windproof and breathable fabrics
- Also suited for use on other outdoor clothing, e.g. fleece and shoes
- Silicone free for ventilation



STIMEX LEAK REPAIR

CODE: STPR | LIQUID | VOLUME: 80ML

- Leak repair for punctures and holes in PVC and vinyl
- Can be used underwater
- Includes applicator brush



STIMEX SEAM SEALER

CODE: STSS | LIQUID | VOLUME: 85ML

- Waterproofing compound for use on inside of seams
- Includes applicator brush



STIMEX CAMPER CLEANER

CODE: STCC | LIQUID | VOLUME: 500ML

- For use in caravans, campers, boats, cars and interiors, barbeques, garden furniture
- Removes algae, tar, insects, dirt
- Environmentally friendly



STIMEX TENT CLEANER

CODE: STTC | LIQUID | VOLUME: 500ML

- Detergent for tents, garden parasols, sun shades, awnings, boat sails, chair cushions
- Removes seasonal soiling
- Environmentally friendly
- Treats approx. 50m² of material (e.g. canvas, cotton, dralon, acrylic, nylon, polyester, PVC coatings)



POLY WEBBING

CODE: PW20 | 20MM (W) X 50M (L)
CODE: PW25 | 25MM (W) X 50M (L)
CODE: PW38 | 38MM (W) X 50M (L)
CODE: PW50 | 50MM (W) X 50M (L)



SEAT BELT WEBBING

CODE: SBW25 | 25MM (W) X 100M (L)
CODE: SBW50 | 50MM (W) X 100M (L)



BACK-TO-BACK HOOK & LOOP TAPE

CODE: BB25 | BLK. | 25MM (W) X 12.5M (L)
CODE: BB50 | BLK. | 50MM (W) X 12.5M (L)

HOOK & LOOP TAPE, 25MM SEW ON

CODE: HSW25BL | BLACK HOOK | 25MM (W) X 25M (L)
CODE: LSW25BL | BLACK LOOP | 25MM (W) X 25M (L)
CODE: HSW25WH | WHITE HOOK | 25MM (W) X 25M (L)
CODE: LSW25WH | WHITE LOOP | 25MM (W) X 25M (L)

CODE: HSW25BE | BEIGE HOOK | 25MM (W) X 25M (L)
CODE: LSW25BE | BEIGE LOOP | 25MM (W) X 25M (L)
CODE: HSW25GR | GREY HOOK | 25MM (W) X 25M (L)
CODE: LSW25GR | GREY LOOP | 25MM (W) X 25M (L)

HOOK & LOOP TAPE, 50MM SEW ON

CODE: HSW50BL | BLACK HOOK | 50MM (W) X 25M (L)
CODE: LSW50BL | BLACK LOOP | 50MM (W) X 25M (L)
CODE: HSW50WH | WHITE HOOK | 50MM (W) X 25M (L)
CODE: LSW50WH | WHITE LOOP | 50MM (W) X 25M (L)

CODE: HSW50BE | BEIGE HOOK | 50MM (W) X 25M (L)
CODE: LSW50BE | BEIGE LOOP | 50MM (W) X 25M (L)
CODE: HSW50GR | GREY HOOK | 50MM (W) X 25M (L)
CODE: LSW50GR | GREY LOOP | 50MM (W) X 25M (L)

HOOK & LOOP TAPE, 25MM SELF ADHESIVE

CODE: HSA25BL | BLACK HOOK | 25MM (W) X 25M (L)
CODE: LSA25BL | BLACK LOOP | 25MM (W) X 25M (L)
CODE: HSA25WH | WHITE HOOK | 25MM (W) X 25M (L)
CODE: LSA25WH | WHITE LOOP | 25MM (W) X 25M (L)

HOOK & LOOP TAPE, 50MM SELF ADHESIVE

CODE: HSA50BL | BLACK HOOK | 50MM (W) X 25M (L)
CODE: LSA50BL | BLACK LOOP | 50MM (W) X 25M (L)
CODE: HSA50WH | WHITE HOOK | 50MM (W) X 25M (L)
CODE: LSA50WH | WHITE LOOP | 50MM (W) X 25M (L)





SIDE RELEASE BUCKLES

CODE: SRB19 | 19MM
 CODE: SRB25 | 25MM
 CODE: SRB38 | 38MM
 CODE: SRB50 | 50MM



TRIGLIDES

CODE: 66C | 19MM
 CODE: 66D | 25MM
 CODE: 66E | 38MM
 CODE: 66F | 50MM



LADDER LOCK

CODE: 66G | 19MM
 CODE: 66H | 25MM



D RINGS

CODE: DR1 | 3.2MM (DIA.) X 25MM (W) X 21MM (D)
 CODE: DR2 | 5MM (DIA.) X 25MM (W) X 23MM (D)
 CODE: DR3 | 6MM (DIA.) X 25MM (W) X 38MM (D)
 CODE: DR4 | 6MM (DIA.) X 25MM (W) X 46MM (D)



VERTICAL T-TOGGLE WITH METAL FLIPPER

CODE: 66NW | WHITE
 CODE: 66NB | BLACK
 CODE: 66NWD | WHITE, DOUBLE
 CODE: 66NBD | BLACK, DOUBLE



HORIZONTAL T-TOGGLE WITH METAL FLIPPER

CODE: 66OW | WHITE
 CODE: 66OB | BLACK
 CODE: 66OWD | WHITE, DOUBLE
 CODE: 66OBD | BLACK, DOUBLE



CANVAS TO CANVAS T-TOGGLE WITH METAL FLIPPER

CODE: 66IW | WHITE
 CODE: 66IB | BLACK
 CODE: 66IWD | WHITE, DOUBLE
 CODE: 66IBD | BLACK, DOUBLE

ROPES & PEGS





STEEL TENT PEGS

- CODE: 39Ai | BULK PACK OF 100 | 4MM (DIA.) X 175MM (L)
- CODE: 39ALi | BULK PACK OF 100 | 6.3MM (DIA.) X 175MM (L)
- CODE: 39Bi | BULK PACK OF 100 | 6.3MM (DIA.) X 225MM (L)
- CODE: 39Ji | BULK PACK OF 100 | 8MM (DIA.) X 225MM (L)
- CODE: 39Ci | BULK PACK OF 100 | 8MM (DIA.) X 300MM (L)
- CODE: 39Di | BULK PACK OF 100 | 9.5MM (DIA.) X 350MM (L)
- CODE: 39H | BULK PACK OF 50 | 12MM (DIA.) X 450MM (L)

PLASTIC SAND PEGS

- CODE: 39E | BULK PACK OF 100 | 220MM (L)
- CODE: 39F | BULK PACK OF 100 | 300MM (L)
- CODE: 39G | BULK PACK OF 50 | 500MM (L)

- Zinc plated
- Individually barcoded

- Manufactured from Australian polypropylene



STEEL TENT PEGS, HANG SELL

- CODE: 39AP | BAG OF 10 | 4MM D. X 175MM (L)
- CODE: 39ALP | BAG OF 10 | 6.3MM D. X 175MM (L)
- CODE: 39BP | BAG OF 10 | 6.3MM D. X 225MM (L)
- CODE: 39BLP | BAG OF 10 | 6.3MM D. X 300MM (L)
- CODE: 39JP | BAG OF 6 | 8MM D. X 225MM (L)
- CODE: 39CP | BAG OF 6 | 8MM D. X 300MM (L)
- CODE: 39DP | BAG OF 4 | 9.5MM D. X 350MM (L)

PLASTIC SAND PEGS, HANG SELL

- CODE: 39EP | HANG SELL BAG OF 6 | 220MM (L)
- CODE: 39FP | HANG SELL BAG OF 4 | 300MM (L)
- CODE: 39GP | HANG SELL BAG OF 3 | 500MM (L)

TENT PEG BAG

- CODE: TPB
- Canvas bag for pegs & guy ropes

Dimensions:
450mm (l) x 100mm (w) x
100mm (h)



LARGE ALLOY SCREW IN PEGS

CODE: ALPEG-L

- Pack includes 4x large alloy screw in pegs (30cm) and 4x large gey rope clips
- Alloy screw in pegs designed to provide a secure anchor point for guy ropes, gazebos and awning tie down kits
- Designed to suit the 17mm Drill Adaptor (sold separately) that allows the screw to be quickly driven into the ground with ease
- Designed to suit most environments; grass, gravel/stones, sand, soft to dense ground

Dimensions:

300mm (l) x 17mm dia. head

NEW!



MEDIUM ALLOY SCREW IN PEGS

CODE: ALPEG-M

- Pack includes 4x medium alloy screw in pegs (20cm) and 4x medium gey rope clips
- Alloy screw in pegs designed to provide a secure anchor point for guy ropes, gazebos and awning tie down kits
- Designed to suit the 17mm Drill Adaptor (sold separately) that allows the screw to be quickly driven into the ground with ease
- Designed to suit most environments; grass, gravel/stones, sand, soft to dense ground

Dimensions:

200mm (l) x 17mm dia. head

NEW!

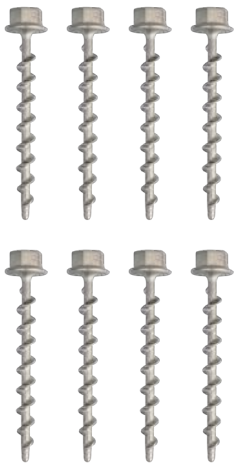

SMALL ALLOY SCREW IN PEGS

CODE: ALPEG-S

- Pack includes 8x small alloy screw in pegs (12cm)
- Alloy screw in pegs designed to provide a secure anchor point for guy ropes, gazebos and awning tie down kits
- Designed to suit the 17mm Drill Adaptor (sold separately) that allows the screw to be quickly driven into the ground with ease
- Designed to suit most environments; grass, gravel/stones, sand, soft to dense ground

Dimensions:

120mm (l) x 17mm dia. head

NEW!

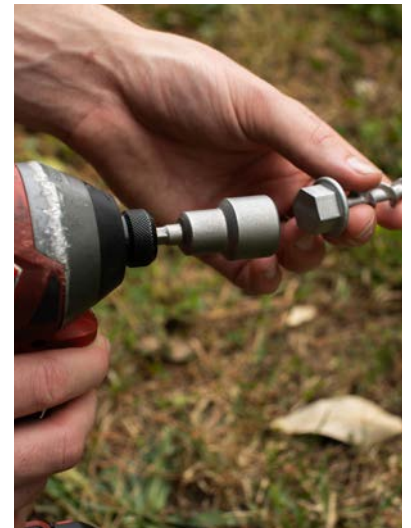

ALLOY SCREW IN PEG DRILL ADAPTOR

CODE: ALPEG-DA

- 17mm drill adaptor to suit large, medium and small alloy screw in pegs

Dimensions:

17mm dia.

NEW!

SCREW IN MAT PEGS

CODE: MTPEG

- Pack includes 8 x Screw In Mat Pegs, 1x T40 Drill bit, 1x storage bag
- Flush head design
- Zinc plated
- Designed to suit most environments: grass, gravel/ stones, sand, soft to dense ground

Dimensions:
140mm (l) x 21mm dia. head

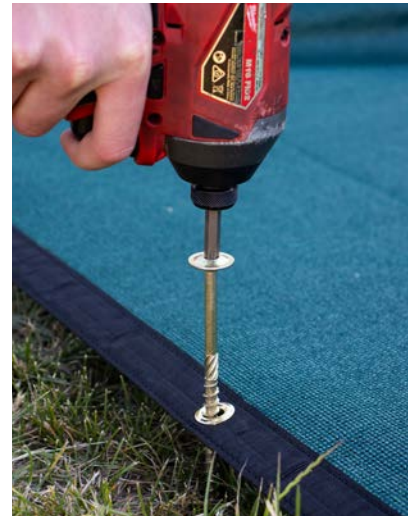

NEW!

DELUXE ALLOY SCREW IN PEG KIT

CODE: ALPEG-DK

- Pack includes 4x large alloy pegs (30cm), 4x medium alloy pegs (20cm), 4x small alloy pegs (12cm), 4x large guy rop clips, 4x medium guy rope clips, 1x 17mm drill adaptor and x carry bag
- Alloy screw in pegs designed to provide a secure anchor point for guy ropes, gazebos and awning tie down kits.
- Designed to suit most environments: grass, gravel/ stones, sand, soft to dense ground

Dimensions vary for different peg sizes



NEW!

SCREW IN SAND PEG KIT

CODE: SPEG

- Pack includes 6x large screw in sand pegs (40cm), 1x storage bag and 1x 19mm drill adaptor.
- Sand pegs suitable for soft soil.
- Made from durable reinforced nylon

Dimensions: 400mm (l)



NEW!



GUY ROPE, PLASTIC SLIDE

CODE: 38L | SINGLE, 4MM ROPE
 CODE: 38Q | SINGLE, 6MM ROPE
 CODE: 38QQ | DOUBLE, 6MM ROPE



GUY ROPE, POLYMER SLIDE

CODE: 32B | SINGLE, SPRING, 6MM ROPE
 CODE: 32BB | DOUBLE, SPRING, 6MM ROPE



GUY ROPE, TIMBER SLIDE

CODE: 38J | SINGLE, 6MM ROPE
 CODE: 38JJ | DOUBLE, 6MM ROPE
 CODE: 38K | SINGLE, SPRING, 6MM ROPE
 CODE: 38KK | DOUBLE, SPRING, 6MM ROPE

SILVER TORNADO TARP, 120GSM

CODE: 12AXSUP4X6 | 4FT X 6FT | 1200MM X 1800MM
 CODE: 12AXSUP5X7 | 5FT X 7FT | 1500MM X 2100MM
 CODE: 12AXSUP6X8 | 6FT X 8FT | 1800MM X 2400MM
 CODE: 12AXSUP8X10 | 8FT X 10FT | 2400MM X 3000MM
 CODE: 12AXSUP10X12 | 10FT X 12FT | 3000MM X 3600MM
 CODE: 12AXSUP12X14 | 12FT X 14FT | 3600MM X 4300MM
 CODE: 12AXSUP12X16 | 12FT X 16FT | 3600MM X 4800MM
 CODE: 12AXSUP16X24 | 16FT X 24FT | 4800MM X 7300MM
 CODE: 12AXSUP20X26 | 20FT X 26FT | 6100MM X 7900MM
 CODE: 12AXSUP20X30 | 20FT X 30FT | 6100MM X 9100MM
 CODE: 12AXSUP22X30 | 22FT X 30FT | 6700MM X 9100MM
 CODE: 12AXSUP24X30 | 24FT X 30FT | 7300MM X 9100MM

- All measurements are finished sizes, so you use every centimetre you pay for
- Swiss patented technology
- Guaranteed lifetime waterproof
- Tear resistant and ripstop material
- No peeling / cracking, puncture resistant
- Extra heavy duty
- High tensile strength
- 100% recyclable
- Engineered stretch and elongation
- Ultrasonic reinforced aluminium welded eyelets
- UV resistant for 3 years

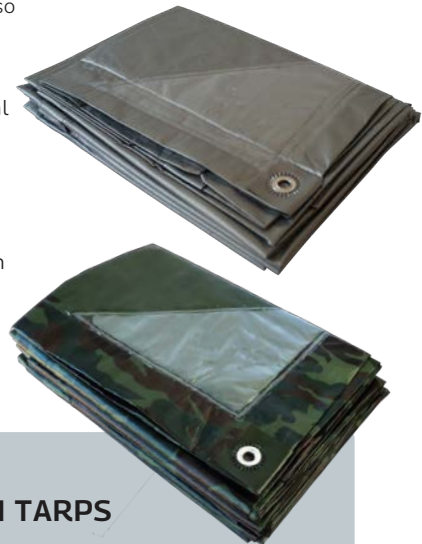

CAMO TORNADO TARP, 150GSM

CODE: 12AXSUP6X8CAMO | 6FT X 8FT | 1800MM X 2400MM
 CODE: 12AXSUP10X12CAMO | 10FT X 12FT | 3000MM X 3600MM
 CODE: 12AXSUP16X24CAMO | 16FT X 24FT | 4800MM X 7300MM

3 LAYERS OF XF FILM
3 X SUPERIOR TO WOVEN TARPS
3 YEAR QUALITY GUARANTEE



TORNADO TARPS SHELF READY CARTON



HOLD TIGHT TARP GRIPPER

CODE: SHO38I | INDIVIDUAL
 CODE: SHO38P | PACK OF 4
 CODE: SHO38C | DISPLAY CARTON HOLDS 15 X PACKS OF 4



BUNGEE CORD WITH TOGGLE BALL

CODE: ELO2
 - For tying down tarpaulins and/or privacy screens



ELASTIC SHOCK CORD WITH HOOK

CODE: ESCH
 - Tension absorber with plastic coated hook



POLYPROPYLENE ROPE

CODE: 34AC | 4MM COIL | 250M
 CODE: 34BC | 6MM COIL | 250M
 CODE: 34DC | 10MM COIL | 250M
 CODE: 34EC | 12MM COIL | 250M



SILVER ROPE

CODE: 34HR | 4MM REEL | 300M
 CODE: 34FC | 6MM COIL | 250M
 CODE: 34FR | 6MM REEL | 300M
 CODE: 34GC | 8MM COIL | 250M
 CODE: 34GR | 8MM REEL | 200M
 CODE: 34IC | 10MM COIL | 250M
 CODE: 34IR | 10MM REEL | 125M
 CODE: 34JC | 12MM COIL | 250M
 CODE: 34JR | 12MM REEL | 125M



MINI COILS

CODE: MC1 | 4MM (DIA.) X 20M (L) | 5 PACK
 CODE: MC2 | 6MM (DIA.) X 20M (L) | 5 PACK



SPLICE CLIP

CODE: 39K | FITS 6MM ROPE



BLACK SHOCK CORD

CODE: SCO2 | 2MM (DIA.) X 100M (L)
 CODE: SCO3 | 3MM (DIA.) X 100M (L)
 CODE: SCO4 | 4MM (DIA.) X 100M (L)
 CODE: SCO5 | 5MM (DIA.) X 100M (L)
 CODE: SCO6 | 6MM (DIA.) X 100M (L)
 CODE: SCO7 | 7MM (DIA.) X 50M (L)
 CODE: SCO8 | 8MM (DIA.) X 50M (L)
 CODE: SCO10 | 10MM (DIA.) X 50M (L)

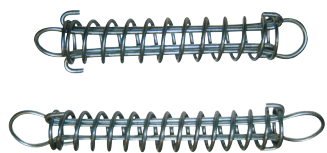

TRACE SPRINGS

CODE: 38C | 150MM / 6"
 CODE: 38D | 200MM / 8"



POLYMER SLIDE

CODE: 32C
 - To suit 4mm, 6mm & 8mm rope



TIMBER SLIDE

CODE: 38G
 Dimensions:
 30mm (dia.) x 140mm (l)



COMBO SLIDE

CODE: 38B
 - Plastic slide to suit 4mm & 6mm rope



FASTENER HOOK

CODE: 66A | 6MM
 CODE: 66B | 8MM



SHOCK CORD HOOK

CODE: KB2 | PLASTIC
 CODE: KB3 | METAL



SHOCK CORD KNOB

CODE: KB1



SHOCK CORD LOOP

CODE: LP1 | L:70MM, C:150MM
 CODE: LP2 | L:80MM, C:170MM
 CODE: LP3 | L:90MM, C:190MM
 CODE: LP4 | L:100M, C:209MM

POLES & SPREADER BARS



TENT POLE - T NUT - IMPORTED

CODE: 564CI | 19-22MM DIA. X 0.9WT - MAX. 183CM (6') | COLLAPSED LENGTH: ~113CM
 CODE: 564DI | 19-22MM DIA. X 0.9WT - MAX. 228CM (7'6") | COLLAPSED LENGTH: ~129CM
 CODE: 564EI | 19-22MM DIA. X 0.9WT - MAX. 274CM (9') | COLLAPSED LENGTH: ~149CM



EXTENSION POLE - T NUT

CODE: 564C | 19-22MM DIA. X 0.9WT - MAX. 183CM (6') | COLLAPSED LENGTH: ~110CM
 CODE: 564D | 19-22MM DIA. X 0.9WT - MAX. 228CM (7'6") | COLLAPSED LENGTH: ~122CM
 CODE: 564B | 19-22MM DIA. X 0.9WT - MAX. 243CM (8') | COLLAPSED LENGTH: ~133CM
 CODE: 564E | 19-22MM DIA. X 0.9WT - MAX. 274CM (9') | COLLAPSED LENGTH: ~146CM
 CODE: 564F | 19-22MM DIA. X 0.9WT - MAX. 305CM (10') | COLLAPSED LENGTH: ~169CM



EXTENSION SUPPORT POLE - T NUT - CLIP 1 END

CODE: 564DC | 19-22MM DIA. X 0.9WT - MAX. 228CM (7'6") - CLIP END | COLLAPSED LENGTH: ~125CM
 CODE: 564BC | 19-22MM DIA. X 0.9WT - MAX. 243CM (8') - CLIP END | COLLAPSED LENGTH: ~136CM
 CODE: 564EC | 19-22MM DIA. X 0.9WT - MAX. 274CM (9') - CLIP END | COLLAPSED LENGTH: ~149CM
 CODE: 564FC | 19-22MM DIA. X 0.9WT - MAX. 305CM (10') - CLIP END | COLLAPSED LENGTH: ~166CM



EXTENSION SUPPORT POLE - T NUT - SQUARE C CLIP

CODE: 564DSQC | 19-22MM DIA. X 0.9WT - MAX. 228CM (7'6") - SQUARE CLIP END | COLLAPSED LENGTH: ~125CM
 CODE: 564BSQC | 19-22MM DIA. X 0.9WT - MAX. 243CM (8') - SQUARE CLIP END | COLLAPSED LENGTH: ~136CM
 CODE: 564ESQC | 19-22MM DIA. X 0.9WT - MAX. 274CM (9') - SQUARE CLIP END | COLLAPSED LENGTH: ~149CM
 CODE: 564FSQC | 19-22MM DIA. X 0.9WT - MAX. 305CM (10') - SQUARE CLIP END | COLLAPSED LENGTH: ~166CM



THREE PIECE EXTENSION POLE

CODE: 564H | 19-22-25MM DIA. X 0.9WT - MAX. 243CM (8') | COLLAPSED LENGTH: ~96CM
 CODE: 564I | 19-22-25MM DIA. X 0.9WT - MAX. 305CM (10') | COLLAPSED LENGTH: ~116CM
 CODE: 564G | 19-22-25MM DIA. X 0.9WT - MAX. 366CM (12') | COLLAPSED LENGTH: ~138CM



EXTENSION - T NUT - THREADED SPIGOT

CODE: 564CT | 19-22MM DIA. X 0.9WT - MAX. 183CM (6') - THREADED SPIGOT | COLLAPSED LENGTH: ~110CM
 CODE: 564DT | 19-22MM DIA. X 0.9WT - MAX. 228CM (7'6") - THREADED SPIGOT | COLLAPSED LENGTH: ~126CM
 CODE: 564BT | 19-22MM DIA. X 0.9WT - MAX. 243CM (8') - THREADED SPIGOT | COLLAPSED LENGTH: ~133CM
 CODE: 564ET | 19-22MM DIA. X 0.9WT - MAX. 274CM (9') - THREADED SPIGOT | COLLAPSED LENGTH: ~146CM
 CODE: 564FT | 19-22MM DIA. X 0.9WT - MAX. 305CM (10') - THREADED SPIGOT | COLLAPSED LENGTH: ~169CM



SWAG POLE

CODE: 564A | 16-19MM DIA. X 0.9WT - MAX. 122CM (4') | COLLAPSED LENGTH: ~74CM



EXTENSION POLE - T NUT - HEAVY DUTY

CODE: 464D | 19-22MM DIA. X 1.2WT - MAX. 228CM (7'6") | COLLAPSED LENGTH: ~126CM
 CODE: 464E | 19-22MM DIA. X 1.2WT - MAX. 274CM (9') | COLLAPSED LENGTH: ~146CM
 CODE: 364D | 22-25MM DIA. X 1.2WT - MAX. 228CM (7'6") | COLLAPSED LENGTH: ~126CM
 CODE: 364E | 22-25MM DIA. X 1.2WT - MAX. 274CM (9') | COLLAPSED LENGTH: ~146CM



EXTENSION POLE - WELDED SPIGOT

CODE: 564CWS | 19-22MM DIA. X 0.9WT - MAX. 183CM (6') - SOLID WELDED METAL SPIGOT | COLLAPSED LENGTH: ~113CM
 CODE: 564DWS | 19-22MM DIA. X 0.9WT - MAX. 228CM (7'6") - SOLID WELDED METAL SPIGOT | COLLAPSED LENGTH: ~129CM
 CODE: 564BWS | 19-22MM DIA. X 0.9WT - MAX. 243CM (8') - SOLID WELDED METAL SPIGOT | COLLAPSED LENGTH: ~136CM
 CODE: 564EWS | 19-22MM DIA. X 0.9WT - MAX. 274CM (9') - SOLID WELDED METAL SPIGOT | COLLAPSED LENGTH: ~149CM
 CODE: 564FWS | 19-22MM DIA. X 0.9WT - MAX. 305CM (10') - SOLID WELDED METAL SPIGOT | COLLAPSED LENGTH: ~172CM



TENT POLE BAG

CODE: LPB

- Canvas bag to suit tent poles

Dimensions:

1.65m (l) x 80mm (w) x 160mm (h)





SPREADER BARS - T NUT - EYE BOTH ENDS

CODE: 564K | 19-22MM DIA. X 0.9WT - MAX. 122CM (4') - 2 PIECE | COLLAPSED LENGTH: ~73CM
 CODE: 564L | 19-22MM DIA. X 0.9WT - MAX. 152CM (5') - 2 PIECE | COLLAPSED LENGTH: ~88CM
 CODE: 564M | 19-22MM DIA. X 0.9WT - MAX. 183CM (6') - 2 PIECE | COLLAPSED LENGTH: ~103CM
 CODE: 564N | 19-22MM DIA. X 0.9WT - MAX. 213CM (7') - 2 PIECE | COLLAPSED LENGTH: ~126CM
 CODE: 564O | 19-22MM DIA. X 0.9WT - MAX. 243CM (8') - 2 PIECE | COLLAPSED LENGTH: ~137CM
 CODE: 564P | 19-22MM DIA. X 0.9WT - MAX. 274CM (9') - 2 PIECE | COLLAPSED LENGTH: ~150CM
 CODE: 564Q | 19-22MM DIA. X 0.9WT - MAX. 305CM (10') - 2 PIECE | COLLAPSED LENGTH: ~167CM
 CODE: 564S | 22-25MM DIA. X 1.2WT - MAX. 365CM (12') - 3 PIECE | COLLAPSED LENGTH: ~130CM
 CODE: 564X | 22-25MM DIA. X 1.2WT - MAX. 427CM (14') - 3 PIECE | COLLAPSED LENGTH: ~152CM
 CODE: 564Y | 22-25MM DIA. X 1.2WT - MAX. 488CM (16') - 4 PIECE | COLLAPSED LENGTH: ~133CM
 CODE: 564Z | 22-25MM DIA. X 1.2WT - MAX. 548CM (18') - 4 PIECE | COLLAPSED LENGTH: ~148CM



SPREADER BARS - T NUT - CLIP 1 END

CODE: 564KC | 19-22MM DIA. X 0.9WT - MAX. 122CM (4') - 2 PIECE, CLIP END | COLLAPSED LENGTH: ~76CM
 CODE: 564LC | 19-22MM DIA. X 0.9WT - MAX. 152CM (5') - 2 PIECE, CLIP END | COLLAPSED LENGTH: ~91CM
 CODE: 564MC | 19-22MM DIA. X 0.9WT - MAX. 183CM (6') - 2 PIECE, CLIP END | COLLAPSED LENGTH: ~106CM
 CODE: 564NC | 19-22MM DIA. X 0.9WT - MAX. 213CM (7') - 2 PIECE, CLIP END | COLLAPSED LENGTH: ~129CM
 CODE: 564OC | 19-22MM DIA. X 0.9WT - MAX. 243CM (8') - 2 PIECE, CLIP END | COLLAPSED LENGTH: ~140CM
 CODE: 564PC | 19-22MM DIA. X 0.9WT - MAX. 274CM (9') - 2 PIECE, CLIP END | COLLAPSED LENGTH: ~153CM



SPREADER BARS - T NUT - CLIP 2 ENDS

CODE: 564KC2 | 19-22MM DIA. X 0.9WT - MAX. 122CM (4') - 2 PIECE, CLIP 2 ENDS | COLLAPSED LENGTH: ~74CM
 CODE: 564LC2 | 19-22MM DIA. X 0.9WT - MAX. 152CM (5') - 2 PIECE, CLIP 2 ENDS | COLLAPSED LENGTH: ~89CM
 CODE: 564MC2 | 19-22MM DIA. X 0.9WT - MAX. 183CM (6') - 2 PIECE, CLIP 2 ENDS | COLLAPSED LENGTH: ~104CM
 CODE: 564NC2 | 19-22MM DIA. X 0.9WT - MAX. 213CM (7') - 2 PIECE, CLIP 2 ENDS | COLLAPSED LENGTH: ~127CM
 CODE: 564OC2 | 19-22MM DIA. X 0.9WT - MAX. 243CM (8') - 2 PIECE, CLIP 2 ENDS | COLLAPSED LENGTH: ~138CM
 CODE: 564PC2 | 19-22MM DIA. X 0.9WT - MAX. 274CM (9') - 2 PIECE, CLIP 2 ENDS | COLLAPSED LENGTH: ~151CM



HEAVY DUTY SQUARE SPREADER BARS

CODE: SR12 | 22-25MM - MAX. 365CM (12') - 3 PIECE | COLLAPSED LENGTH: ~133CM
 CODE: SR15 | 22-25MM - MAX. 457CM (15') - 3 PIECE | COLLAPSED LENGTH: ~163CM
 CODE: SR18 | 22-25MM - MAX. 548CM (18') - 4 PIECE | COLLAPSED LENGTH: ~155CM
 CODE: SR20 | 22-25MM - MAX. 608CM (20') - 4 PIECE | COLLAPSED LENGTH: ~163CM
 CODE: SR24 | 22-25MM - MAX. 730CM (24') - 5 PIECE | COLLAPSED LENGTH: ~163CM
 CODE: SR30 | 22-25MM - MAX. 912CM (30') - 6 PIECE | COLLAPSED LENGTH: ~163CM
 CODE: SR36 | 22-25MM - MAX. 1096CM (36') - 8 PIECE | COLLAPSED LENGTH: ~155CM



ROOF RAILS - T NUT (INCLUDING BRACKET)



CODE: 564T | 19-22MM DIA. X 0.9WT – MAX. 243CM (8') - EYE END | COLLAPSED LENGTH: ~137CM
 CODE: 564V | 19-22MM DIA. X 0.9WT – MAX. 274CM (9') - EYE END | COLLAPSED LENGTH: ~150CM
 CODE: 564W | 19-22MM DIA. X 0.9WT – MAX. 305CM (10') - EYE END | COLLAPSED LENGTH: ~167CM



ROOF RAILS - T NUT (INCLUDING BRACKET) - CLIP END



CODE: 564TC | 19-22MM DIA. X 0.9WT – MAX. 243CM (8') - CLIP END | COLLAPSED LENGTH: ~140CM
 CODE: 564VC | 19-22MM DIA. X 0.9WT – MAX. 274CM (9') - CLIP END | COLLAPSED LENGTH: ~153CM
 CODE: 564WC | 19-22MM DIA. X 0.9WT – MAX. 305CM (10') - CLIP END | COLLAPSED LENGTH: ~170CM



ROOF RAILS - T NUT (INCLUDING BRACKET) - SPIGOT END



CODE: 564TS | 19-22MM DIA. X 0.9WT – MAX. 243CM (8') - SPIGOT END | COLLAPSED LENGTH: ~143CM
 CODE: 564VS | 19-22MM DIA. X 0.9WT – MAX. 274CM (9') - SPIGOT END | COLLAPSED LENGTH: ~156CM
 CODE: 564WS | 19-22MM DIA. X 0.9WT – MAX. 305CM (10') - SPIGOT END | COLLAPSED LENGTH: ~173CM



ALUMINIUM TENT POLES - TWIST LOCK



CODE: 264S | 22-25MM DIA. X 1.2WT – MAX. 228CM (7'6") - MILL FINISH | COLLAPSED LENGTH: ~131CM
 CODE: 264SW | 22-25MM DIA. X 1.2WT – MAX. 228CM (7'6") - WHITE FINISH | COLLAPSED LENGTH: ~131CM
 CODE: 264SB | 22-25MM DIA. X 1.2WT – MAX. 228CM (7'6") - BLACK FINISH | COLLAPSED LENGTH: ~131CM
 CODE: 264T | 22-25MM DIA. X 1.2WT – MAX. 274CM (9') - MILL FINISH | COLLAPSED LENGTH: ~155CM
 CODE: 264TW | 22-25MM DIA. X 1.2WT – MAX. 274CM (9') - WHITE FINISH | COLLAPSED LENGTH: ~155CM
 CODE: 264TB | 22-25MM DIA. X 1.2WT – MAX. 274CM (9') - BLACK FINISH | COLLAPSED LENGTH: ~155CM
 CODE: 264TG | 22-25MM DIA. X 1.2WT – MAX. 274CM (9') - GREY FINISH | COLLAPSED LENGTH: ~150CM



ALUMINIUM TENT POLES - TWIST LOCK - CLIP END



CODE: 264SC | 22-25MM DIA. X 1.2WT – MAX. 228CM (7'6") - CLIP END, MILL FINISH | COLLAPSED LENGTH: ~129CM
 CODE: 264SWC | 22-25MM DIA. X 1.2WT – MAX. 228CM (7'6") - CLIP END, WHITE FINISH | COLLAPSED LENGTH: ~129CM
 CODE: 264SBC | 22-25MM DIA. X 1.2WT – MAX. 228CM (7'6") - CLIP END, BLACK FINISH | COLLAPSED LENGTH: ~129CM
 CODE: 264TC | 22-25MM DIA. X 1.2WT – MAX. 274CM (9') - CLIP END, MILL FINISH | COLLAPSED LENGTH: ~153CM
 CODE: 264TWC | 22-25MM DIA. X 1.2WT – MAX. 274CM (9') - CLIP END, WHITE FINISH | COLLAPSED LENGTH: ~153CM
 CODE: 264TBC | 22-25MM DIA. X 1.2WT – MAX. 274CM (9') - CLIP END, BLACK FINISH | COLLAPSED LENGTH: ~153CM
 CODE: 264TGC | 22-25MM DIA. X 1.2WT – MAX. 274CM (9') - CLIP END, GREY FINISH | COLLAPSED LENGTH: ~153CM



ALUMINIUM TENT POLES - CLAMP ADJUSTMENT



CODE: 264SCL | 22-25MM DIA. X 1.2WT – MAX. 228CM (7'6") - MILL FINISH | COLLAPSED LENGTH: ~129CM
 CODE: 264SWCL | 22-25MM DIA. X 1.2WT – MAX. 228CM (7'6") - WHITE FINISH | COLLAPSED LENGTH: ~129CM
 CODE: 264SBCL | 22-25MM DIA. X 1.2WT – MAX. 228CM (7'6") - BLACK FINISH | COLLAPSED LENGTH: ~129CM
 CODE: 264TCL | 22-25MM DIA. X 1.2WT – MAX. 274CM (9') - MILL FINISH | COLLAPSED LENGTH: ~153CM
 CODE: 264TWCL | 22-25MM DIA. X 1.2WT – MAX. 274CM (9') - WHITE FINISH | COLLAPSED LENGTH: ~153CM
 CODE: 264TBCL | 22-25MM DIA. X 1.2WT – MAX. 274CM (9') - BLACK FINISH | COLLAPSED LENGTH: ~153CM
 CODE: 264TGCL | 22-25MM DIA. X 1.2WT – MAX. 274CM (9') - GREY FINISH | COLLAPSED LENGTH: ~153CM



ALUMINIUM SPREADER BARS - CLAMP ADJUSTMENT



CODE: 264N | 22-25MM SPREADER BAR X 1.2WT – MAX. 228CM (7'6") - MILL FINISH | COLLAPSED LENGTH: ~130CM
 CODE: 264NW | 22-25MM SPREADER BAR X 1.2WT – MAX. 228CM (7.6") - WHITE FINISH | COLLAPSED LENGTH: ~130CM
 CODE: 264NB | 22-25MM SPREADER BAR X 1.2WT – MAX. 228CM (7.6") - BLACK FINISH | COLLAPSED LENGTH: ~130CM
 CODE: 264P | 22-25MM SPREADER BAR X 1.2WT – MAX. 274CM (9') - MILL FINISH | COLLAPSED LENGTH: ~154CM
 CODE: 264PB | 22-25MM SPREADER BAR X 1.2WT – MAX. 274CM (9') - BLACK FINISH | COLLAPSED LENGTH: ~154CM
 CODE: 264PG | 22-25MM SPREADER BAR X 1.2WT – MAX. 274CM (9') - GREY FINISH | COLLAPSED LENGTH: ~154CM
 CODE: 264PW | 22-25MM SPREADER BAR X 1.2WT – MAX. 274CM (9') - WHITE FINISH | COLLAPSED LENGTH: ~154CM



ALUMINIUM SPREADER BAR - CLAMP ADJUSTMENT - CLIP 2 ENDS



CODE: 264NC2 | 22-25MM SPREADER BAR X 1.2WT – MAX. 228CM (7'6") - MILL FINISH
 CODE: 264NWC2 | 22-25MM SPREADER BAR X 1.2WT – MAX. 228CM (7'6") - WHITE FINISH
 CODE: 264NBC2 | 22-25MM SPREADER BAR X 1.2WT – MAX. 228CM (7'6") - BLACK FINISH
 CODE: 264PC2 | 22-25MM SPREADER BAR X 1.2WT – MAX. 274CM (9') - MILL FINISH
 CODE: 264PWC2 | 22-25MM SPREADER BAR X 1.2WT – MAX. 274CM (9') - WHITE FINISH
 CODE: 264PBC2 | 22-25MM SPREADER BAR X 1.2WT – MAX. 274CM (9') - BLACK FINISH



ALUMINIUM SPREADER BAR BEND SPIGOT - TO MATCH JAYCO VANS



CODE: 264PJS | 22-25MM SPREADER BAR X 1.2WT – MAX. 274CM (9') - MILL FINISH | COLLAPSED LENGTH: ~156CM
 CODE: 264PJSBE | AS ABOVE WITH BENT SPIGOT & BOW END OUTER



ALUMINIUM SPREADER BAR - SLOTTED BOW END



CODE: 264NSBE | 22-25MM SPREADER BAR X 1.2WT – MAX. 228CM (7'6") - MILL FINISH
 CODE: 264PSBE | 22-25MM SPREADER BAR X 1.2WT – MAX. 274CM (9') - MILL FINISH



TENT POLE ACCESSORIES

POLES & SPREADER BARS

MADE IN AUSTRALIA

HANG SELL AVAILABLE



SPIGOT

CODE: 38U | FITS 19MM TUBE O/D
CODE: 38W | FITS 22MM TUBE O/D
CODE: 38X | FITS 25MM TUBE O/D

MADE IN AUSTRALIA

HANG SELL AVAILABLE



THREADED SPIGOT

CODE: 38UT | FITS 19MM TUBE O/D
CODE: 38WT | FITS 22MM TUBE O/D
CODE: 38XT | FITS 25MM TUBE O/D

MADE IN AUSTRALIA

HANG SELL AVAILABLE



LONG SPIGOTS, 92MM

CODE: 38UL | FITS 19MM TUBE O/D
CODE: 38WL | FITS 22MM TUBE O/D
CODE: 38XL | FITS 25MM TUBE O/D

HANG SELL AVAILABLE



SPIGOT, 6MM DIA. PIN

CODE: 38WS | FITS 22MM TUBE O/D

MADE IN AUSTRALIA

HANG SELL AVAILABLE



BENT SPIGOT

CODE: 38UB | FITS 19MM TUBE O/D
CODE: 38WB | FITS 22MM TUBE O/D
CODE: 38XB | FITS 25MM TUBE O/D

MADE IN AUSTRALIA

HANG SELL AVAILABLE



HOOK BENT SPIGOT

CODE: HBS | FITS 22MM TUBE O/D
CODE: HBS2 | FITS 25MM TUBE O/D

MADE IN AUSTRALIA

HANG SELL AVAILABLE



BOW KNUCKLE

CODE: BK19 | FITS 19MM TUBE O/D
CODE: BK22 | FITS 22MM TUBE O/D
CODE: BK25 | FITS 25MM TUBE O/D

MADE IN AUSTRALIA

HANG SELL AVAILABLE



INTERNAL POLE CAP

CODE: 66Q | 16MM O/D
CODE: 66R | 19MM O/D
CODE: 66S | 22MM O/D
CODE: 66T | 25MM O/D

MADE IN AUSTRALIA

HANG SELL AVAILABLE



EXTERNAL POLE CAP

CODE: 66K | 16MM O/D
CODE: 66L | 19MM O/D
CODE: 66M | 22MM O/D
CODE: 66P | 25MM O/D

MADE IN AUSTRALIA

HANG SELL AVAILABLE



SQUARE C CLIP

CODE: 38PSQ | FOR SQUARE RIDGE POLES

MADE IN AUSTRALIA

HANG SELL AVAILABLE



PLASTIC SNAP CLIP

CODE: 38PS | FITS/SNAPS 19MM TUBE O/D
CODE: 38PM | FITS/SNAPS 19/22MM TUBE O/D
CODE: 38PL | FITS/SNAPS 22MM TUBE O/D
CODE: 38PO | FITS/SNAPS 22/25MM TUBE O/D
CODE: 38PX | FITS/SNAPS 25MM TUBE O/D

MADE IN AUSTRALIA

HANG SELL AVAILABLE



BIRD BEAK & PLATE

CODE: 38E | FITS 22MM/25MM TUBE O/D

MADE IN AUSTRALIA

HANG SELL AVAILABLE



BOW MOUNT

CODE: 39T | BASE SIZE 60MM X 20MM

MADE IN AUSTRALIA

HANG SELL AVAILABLE



BOW MOUNT LARGE

CODE: 39TL | BASE SIZE 70MM X 30MM

HANG SELL AVAILABLE



JAYCO BENT SPIGOT

CODE: JBS | FITS 22MM TUBE O/D SUITS JAYCO ROOF RAIL BRACKET

MADE IN AUSTRALIA

HANG SELL AVAILABLE



S BEND SPIGOT

CODE: SBS1 | FITS 22MM TUBE O/D
CODE: SBS2 | FITS 25MM TUBE O/D

MADE IN AUSTRALIA

HANG SELL AVAILABLE



BOW ENDS

CODE: BE1 | FITS 19MM TUBE O/D
CODE: BE2 | FITS 22MM TUBE O/D
CODE: BE3 | FITS 25MM TUBE O/D

MADE IN AUSTRALIA

HANG SELL AVAILABLE



SLOTTED BOW END

CODE: BE2S | FITS 22MM TUBE O/D
CODE: BE3S | FITS 25MM TUBE O/D

MADE IN AUSTRALIA

HANG SELL AVAILABLE



SQUARE BOW END

CODE: SBE22 | FITS 22MM SQUARE TUBE O/D
CODE: SBE25 | FITS 25MM SQUARE TUBE O/D

HANG SELL AVAILABLE



ROOF RAIL BRACKETS

CODE: 38MS | S / STEEL
CODE: 38MSW | WHITE POWDER COATED S / STEEL
CODE: 38MSB | BLACK POWDER COATED S / STEEL
CODE: 38MSS | S/STEEL REPLACEMENT
CODE: 38MSJ | REPLACEMENT ROOF RAIL BRACKET FOR JAYCO VANS

MADE IN AUSTRALIA

HANG SELL AVAILABLE



WINDOW BRACKET

CODE: 38N | FITS 25MM C-CLIP

MADE IN AUSTRALIA

HANG SELL AVAILABLE



SPIGOT DOME

CODE: 38V

MADE IN AUSTRALIA

HANG SELL AVAILABLE



SPIGOT DOME & SPRING

CODE: 38VSP

MADE IN AUSTRALIA

HANG SELL AVAILABLE



PLASTIC POLE GROUND PLATE

CODE: 38P

HANG SELL AVAILABLE



T NUT & THUMBSCREW

CODE: 38Z | SUITS ALL STEEL POLES

MADE IN AUSTRALIA



QUICK ACTION CLAMP

CODE: PCALC | FITS 22-25MM O/D TUBE
CODE: PCALC22 | FITS 19-22MM O/D TUBE

MADE IN AUSTRALIA



SPRING BUTTON CLIP

CODE: 38R

MADE IN AUSTRALIA



CAMLOK

CODE: CLK | FITS 22MM O/D TUBE
- Internal locking mechanism for aluminium pole

INDEX

A

- 47 ADJUSTABLE LEGS
- 76 AIR PUMP, RECHARGEABLE
- 71 AIR PUMPS
- 86-87 ALLOY SCREW IN PEGS
- 10 ALUMINIUM CARAVAN STEP, BLACK
- 10 ALUMINIUM CARAVAN STEP, TWO-STAGE
- 10 ALUMINIUM CARAVAN STEP, TWO-STAGE, BLACK
- 19 ALUMINIUM CURVED ROOF RAFTERS
- 93-94 ALUMINIUM TENT POLES
- 16 ANNEXE MATTING
- 33 ANODE
- 21 ANTI FLAP KIT SPARE PARTS
- 21 ANTI FLAP KIT STORAGE BAG
- 20 ANTI FLAP KITS (SECURA BARS)
- 18 AWNING & ACCESSORIES
- 22 AWNING ACCESSORIES
- 21 AWNING ADAPTOR BRACKET
- 37,39 AWNING LIGHTS
- 26 AWNING PORCH EXTENSION KIT
- 23 AWNING ROPE CLIP PACKS
- 22 AWNING ROPE CLIPS
- 23 AWNING ROPE CRADLE POLE PACKS
- 22 AWNING TENSIONER

B

- 36-38 BAR LIGHTS
- 39 BARGMAN STYLE LAMP
- 14 BASIN WITH HANDLES
- 14 BASKET, LARGE, SMALL
- 47 BATTERY BOX
- 49 BEARING SETS, A TYPE, B TYPE
- 67 BILLY, ZEBRA
- 10 BLACK CARAVAN STEPS
- 71 BOAT SET, SINGLE, DOUBLE
- 53 BOSTON VALVE
- 95-97 BOW ENDS
- 96 BOW MOUNTS
- 49 BOW SHACKLES
- 13 BOWL, COLLAPSIBLE
- 14 BUCKET
- 88 BUNGEE CORD WITH TOGGLE BALL

C

- 97 CAMLOCK
- 6 CARAVAN STARTER PACKS
- 31 CASSETTE TANK CLEANER
- 64-66 CAST IRON COOKWARE
- 22 CENTRE SUPPORT CRADLE FOR AWNING
- 58 CHAIRETTE
- 55-56 CHAIRS
- 17 CLOTHES ARIERS
- 12 COLANDER
- 12 COLLAPSIBLE CONTAINERS, FOOD PREP
- 13 COLLAPSIBLE COOKWARE
- 14 COLLAPSIBLE TUBS & BASKETS
- 42 COMBINATION REAR LAMPS
- 53 CROSS LEG STRETCHER
- 20 CURVED ROOF RAFTER STORAGE BAG
- 19 CURVED ROOF RAFTERS

D

- 83 D RINGS
- 49 D-SHACKLES
- 6 DELUXE STARTER PACK
- 54-56 DIRECTOR CHAIRS
- 12 DISH DRAINER
- 14 DISH, RECTANGLE
- 12 DOUBLE HANDLE COLANDER
- 8 DRINKING WATER HOSE
- 9 DRINKING WATER HOSE STORAGE BAG
- 79 DRUM SPANNER
- 5 DUAL AXLE WHEEL CHOCK
- 5 DUAL AXLE WHEEL LEVELLING RAMP
- 37 DUAL COLOUR AWNING LIGHT
- 39 DUAL COLOUR READING LIGHT
- 63 DUTCH OVENS

E

- 17 EASY HANG CLOTHESLINE
- 88 ELASTIC SHOCK CORD WITH HOOK
- 9 ELECTRICAL LEAD STORAGE BAG
- 33 ELECTRICAL LEADS
- 25 END WALL PRIVACY SCREENS
- 28 ENSUITE
- 91-92 EXTENSION POLES
- 37 EXTERIOR CARAVAN LIGHTS
- 8 EXTRA FLEXIBLE SULLAGE HOSE
- 36 EXTRA LONG READING LIGHT

F

- 89 FASTNER HOOK
- 34 FANS, CARAVAN HARDWIRED
- 36 FAUX TIMBER READING LIGHT
- 27 FIAMMA AWNING PRIVACY SCREENS
- 33 FLAT PLUG/SOCKET, 7 PIN
- 8 FLEXIBLE SULLAGE HOSE
- 17 FOLDING CLOTHES AIRER
- 71 FOOT BELLOWS
- 13 FRYPAN, COLLAPSIBLE
- 64 FRYPANS
- 79 FUEL DRUMS
- 54-61 FURNITURE

G

- 51 GAS BOTTLE HOLDERS
- 72 GAZEBO
- 16 GROUND MATTING
- 88 GUY ROPES

H

- 33 HAIR DRYER
- 33 HAIR STYLER
- 34 HARDWIRED CARAVAN FAN
- 75 HATCHET
- 10 HEAVY DUTY ADJUSTABLE STEP
- 48 HEX HEAD HANDLE
- 53 HIKER SELF-INFLATING MAT
- 88 HOLD TIGHT TARP GRIPPER
- 82 HOOK & LOOP TAPE
- 58 HOOP LEG STOOLS
- 9 HOSE FITTINGS
- 9 HOSE STORAGE BAGS
- 8 HOSE, CARAVAN

J

- 48 JACK PAD
- 48 JACK PAD STACKER
- 65 JAFFLE IRONS
- 50 JERRY CAN HOLDERS
- 78 JERRY CANS
- 45-46 JOCKEY WHEELS

K

- 13 KETTLE, COLLAPSIBLE
- 67 KETTLE, STAINLESS STEEL

L

- 83 LADDER LOCK
- 22 LARGE CARAVAN AWNING TENSIONER
- 48 LARGE JOCKEY WHEEL HOLDER
- 81 LEAK REPAIR, STIMEX
- 24 LONG WALL PRIVACY SCREENS

M

- 11 MAGAZINE HOLDER
- 75 MALLET
- 43 MARKER LAMPS
- 16 MATTING
- 16 MESH GROUND MATTING
- 10 METAL CARAVAN STEP
- 75 MINI SPLITTER
- 15 MOUNTING BRACKETS

O

- 71 OAR SETS
- 81 OUTDOOR SPRAY, STIMEX
- 38 OYSTER LIGHT

P

- 48 P SERIES HANDLE
- 85 PLASTIC SAND PEGS
- 78 PLASTIC WATER CONTAINERS
- 15 POLE CARRIER/HOLDER
- 82 POLY WEBBING
- 89 POLYPROPYLENE ROPE
- 27 POP TOP CARAVAN END WALL
- 22 POP TOP SUPPORT BAR
- 26 PORCH EXTENSION KIT
- 29 PORTA PAK
- 24 PRIVACY SCREENS
- 16 PVC FOAM CARPET

R

- 5 RAMPS & CHOCKS
- 36-38 READING LIGHTS
- 76 RECHARGEABLE ACCESSORIES
- 76 RECHARGEABLE FAN
- 77 RECHARGEABLE LIGHTS
- 55 RECLINING HARD ARM CHAIR
- 19 ROOF RAFTERS
- 97 ROOF RAIL BRACKETS
- 95 ROOF RAILS
- 89 ROPE
- 12 ROUND CONTAINERS
- 22 RUBBER LADDER STRAP
- 75 RUBBER NOSE CONES
- 75 RUBBER O-RINGS
- 48 RUBBER WHEEL HOLDER
- 5 RV LEVEL BLOCK SET

S

- 13 SAUCEPAN, COLLAPSIBLE
- 85-86 SCREW IN PEGS
- 82 SEAM SEALER, STIMEX
- 82 SEAT BELT WEBBING
- 20 SECURA BARS
- 53 SELF-INFLATING MATTRESS
- 72 SHELTERS
- 89 SHOCK CORD ACCESSORIES
- 89 SHOCK CORD, BLACK
- 75 SHOVELS
- 75 SHOWERS
- 83 SIDE RELEASE BUCKLES
- 89 SILVER ROPE
- 5 SINGLE AXLE WHEEL LEVELLING RAMP
- 11 SINK HAND PUMP
- 11 SINK PLUG
- 14 SINK, COLLAPSIBLE
- 89 SLIDES
- 41 SLIMLINE COMBINATION LAMPS
- 40 SLIMLINE COMBINATION REAR LAMPS
- 21 SPARE PARTS FOR ANTI FLAP KITS
- 21 SPARE PARTS FOR CURVED ROOF RAFTERS
- 96-97 SPIGOTS
- 93 SPREADER BARS
- 66-69 STAINLESS STEELWARE
- 6 STARTER PACKS/KITS
- 85 STEEL TENT PEGS
- 10 STEPS, CARAVAN
- 32, 81 STIMEX
- 56 STOOL, TRI-LEG
- 21 STORAGE BAG FOR ANTI FLAP KITS AND CURVED ROOF RAFTERS
- 9 STORAGE BAG SET
- 8 SULLAGE HOSE
- 9 SULLAGE HOSE STORAGE BAG
- 38 SWIVEL RAIL LIGHT

T

- 83 T TOGGLES
- 11 T-LEVEL
- 59 TABLES
- 88 TARPS, SILVER, CAMO
- 81 TEAR AID
- 81 TENT CLEANER, STIMEX
- 85 TENT PEGS
- 96-97 TENT POLE ACCESSORIES
- 15 TENT POLE HOLDER
- 91-92 TENT POLES
- 73 TENTS & SHELTERS
- 27 TIE DOWN KIT
- 65 TOASTERS
- 33 TOILET CHEMICAL LIQUID
- 31 TOILET CHEMICAL SACHETS
- 33 TOILET PAPER
- 53 TREKWAY SELF-INFLATING MATS
- 53 TREWKAY CROSS-LEG STRETCHER
- 37 TRI-COLOUR CEILING LIGHT - WHITE
- 56 TRI-LEG STOOL
- 82 TRIGLIDES
- 63 TRIPODS
- 14 TUB/SINK, COLLAPSIBLE
- 49 TWIN COUPLING LOCK
- 10 TWO STAGE STEPS

U

- 38 | ULTRA SLIM LIGHT

V

- 53 | VELOUR AIR BEDS
- 77 | VERSA LIGHTS
- 83 | VERTICAL T TOGGLE
- 77 | VIBE LIGHT

W

- 29 | WALEX, CHEMICAL SACHETS
- 60-61 | WANDERLITE FURNITURE
- 78 | WATER CONTAINERS
- 11 | WATER FILTER
- 31 | WATER TANK CLEANER
- 81 | WATERPROOFER, STIMEX
- 5 | WHEEL CHCOK
- 5 | WHEEL LEVELLING RAMP, DUAL AXLE
- 5 | WHEEL LEVELLING RAMP, SINGLE AXLE
- 5 | WHEEL RAMPS & CHOCKS

Z

- 66-69 | ZEBRA STAINLESS STEELWARE

#

- 33 | 7 PIN FLAT PLUG, SOCKET
- 36 | 60MM CARAVAN READING LIGHTS
- 37 | 80MM CARAVAN READING LIGHTS
- 37 | 76MM CARAVAN CEILING LIGHT
- 72 | 3M GAZEBO

supersex